



An innovative press system suitable for **AIR CONDITIONING** and **REFRIGERATION** applications.

**MAXI
PRO
S
QUICK
STRONG
DURABLE**

Technical Submittal June 2019

PROJECT NAME:	
PROJECT REF:	
ENGINEER:	
DATE:	
CONTRACTOR:	
RFI/RPA NUMBER:	

Conex | Bänninger

>B< MaxiPro

www.conexbanninger.com/bmaxipro

Join the Press Revolution

110 years of innovation

Conex Bänninger specializes in providing fittings, valves and accessories across the globe by offering innovative and versatile solutions. Since 1909, Conex Bänninger has produced over 22 billion fittings and valves and has built its reputation for quality European manufacturing, backed by first-class customer service and unrivalled expertise.

Passionate about excellence, Conex Bänninger is a byword for quality in the domestic, commercial, industrial, shipbuilding, air conditioning and refrigeration markets worldwide. Conex Bänninger is an ISO 9001 company, which assures their customers of consistency in the quality of their services and products.



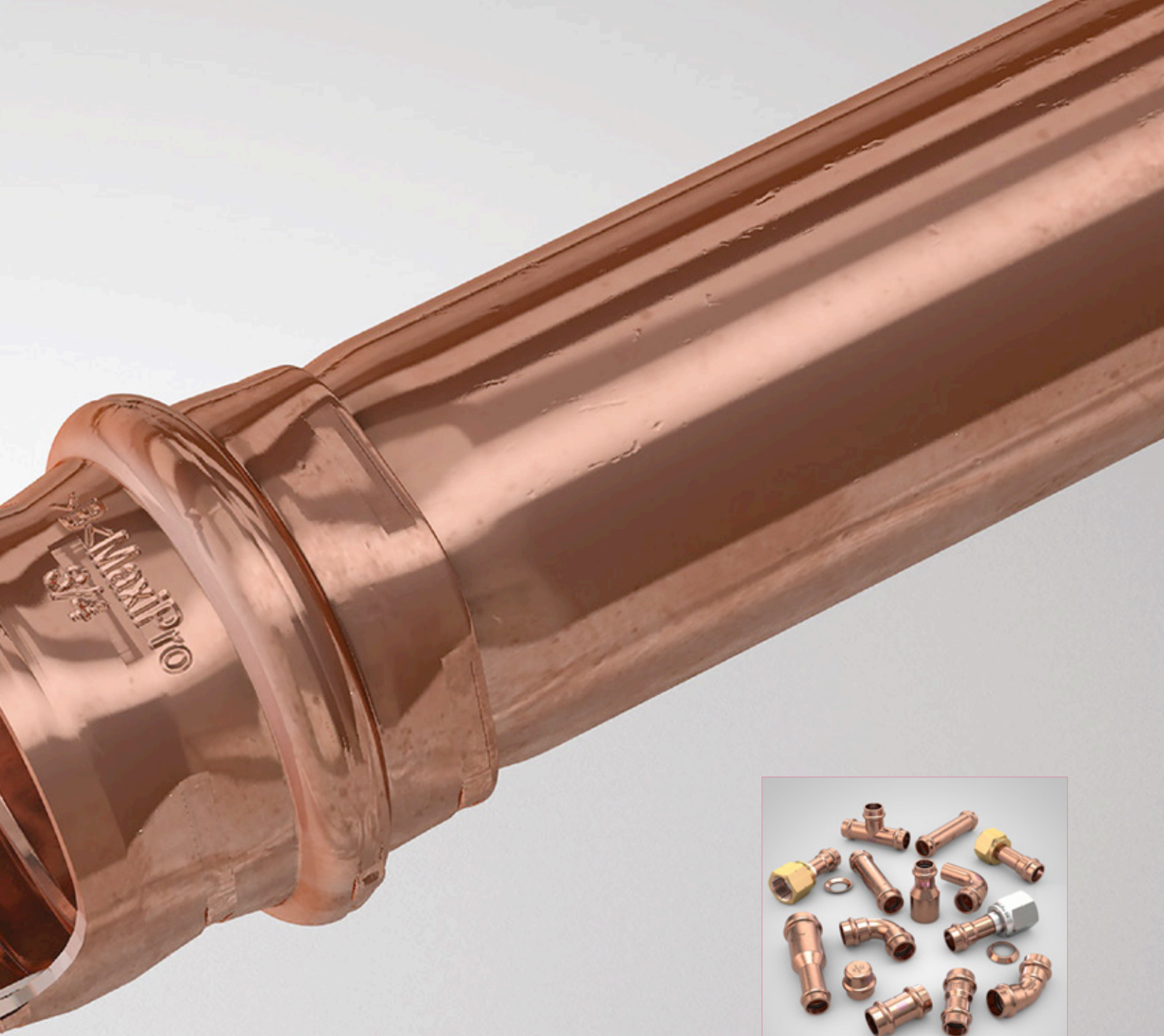

>B< **MaxiPro** is a press fitting system for use with hard, half hard or annealed copper tube conforming to ASTM-B280 or ASTM-B88 type K or L. >B< MaxiPro provides a secure, permanent leak-proof joint suitable for air conditioning and refrigeration applications.

Contents

1.0 Applications	1
2.0 Features and Benefits	2
3.0 Technology - 3 Point Press	3
4.0 Technical Data	4
5.0 Quality Assurance	4
6.0 Trademarks and Patents	4
7.0 Size Availability	4
8.0 Fitting Material	4
9.0 Approvals, Standards and Code Compliance	4
10.0 Fittings Storage	5
11.0 Marking and Cleanliness	5
12.0 Design Considerations	5
12.1 Pipework support	
12.2 Pipework protection	
12.3 Pipework identification and insulation	
12.4 Electrical continuity	
12.5 Space required for the pressing process	
12.6 Insertion depth and minimum distances between pressings	
12.7 Minimum distance for press fittings from an existing brazed joint	
12.8 Minimum brazing distance to an existing pressed fitting	
12.9 Testing and commissioning of air conditioning and refrigeration systems	
12.10 >B< MaxiPro tube compatibility table	
13.0 >B< MaxiPro Installation Process	9
14.0 Frequently Asked Questions	12
15.0 Press Tools and Jaws	14
15.1 ROTHENBERGER ROMAX 4000	
15.2 ROTHENBERGER ROMAX TT US	
15.3 ROTHENBERGER customer service	
15.4 ROTHENBERGER warranty coverage	
16.0 Abbreviations	18
17.0 >B< MaxiPro Product Range	19
18.0 Five-Year Limited Warranty	25
19.0 UL 207 Certificates of Compliance	26
20.0 ICC-ES, PMG-1440 Product Report - Certificate	28

1.0 Applications

>B< MaxiPro fittings are designed for the following applications:

- Refrigeration
- Air conditioning
- Heat pump (refrigeration side)



2.0 Features and Benefits

Flame-free:	Flame-free installation avoids the need for a fire permit and the risk of fire on site.
No nitrogen purge:	>B< MaxiPro is a mechanical joint, thus eliminating the need for nitrogen purge during the jointing process.
Lower installed cost:	A professional fitting which is quick and simple to install, saving time and money.
Higher productivity, improved flexibility:	Work may be completed during working hours / public access, by a single employee.
Site access:	Easy access to work sites, no gas bottles required.
Quality designed in:	Reliable, repeatable, permanent, tamper-proof connections every time.
3-point press:	Three press points, one each side of the bead, and one press compressing the O-ring. This provides a permanent and secure joint.
High quality O-ring:	A high quality HNBR O-ring forms a secure leak-free joint when pressed.
Protected O-ring:	Lead-in edge design aids tube insertion and helps protect the O-ring from damage or displacement.
Fitting identification:	Fittings are marked >B< MaxiPro and identified with a pink mark indicating their suitability for high pressure air conditioning and refrigeration applications.
Electrical continuity:	Maintains ground continuity without the need for additional ground continuity straps.
Certification:	>B< MaxiPro is UL listed, refrigerant fitting SA44668. >B< MaxiPro is UL listed, approved use for field and factory installations.
Field proven:	Press fit technology, field proven over two decades and millions of installed fittings worldwide.
Warranty:	>B< MaxiPro is covered by a five year limited warranty. Please refer to full terms and conditions, see section 18.0.
Support:	Backed by Conex Bänninger's experienced technical support and customer service teams.
Compact tooling:	Light compact tooling provides easy access to tightly spaced tube runs.
Tooling concept:	Only specially designed ROTHENBERGER jaws are approved for use with >B< MaxiPro.

3.0 Technology 3-Point Press

>B< MaxiPro benefits from a 3-point press - three press points; one on each side of the bead and one press compressing the O-ring. This provides a permanent and secure joint.

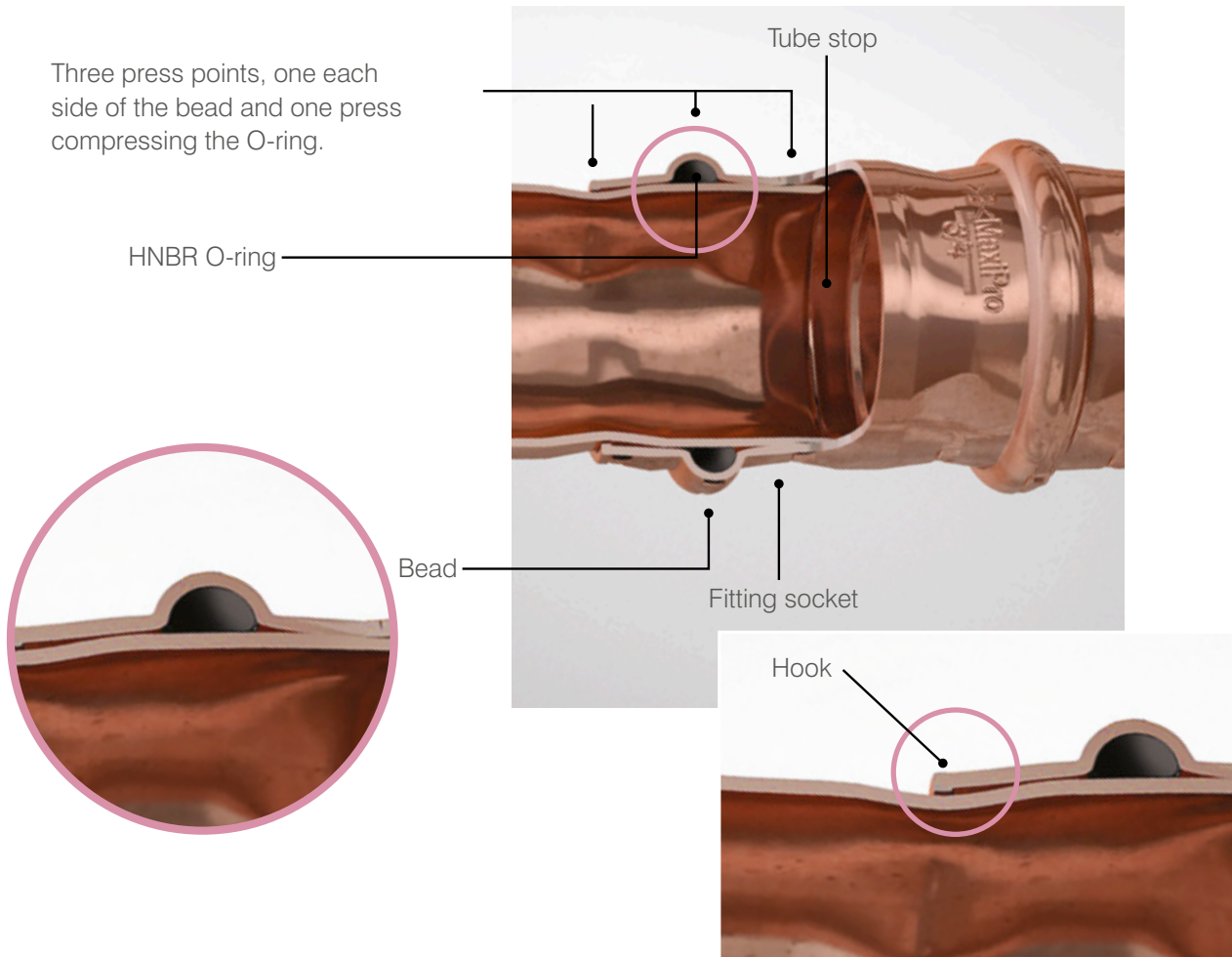

On fittings 1/2" and upwards, a hook ensures that the high pressure performance achieved by >B< MaxiPro fittings is maintained.

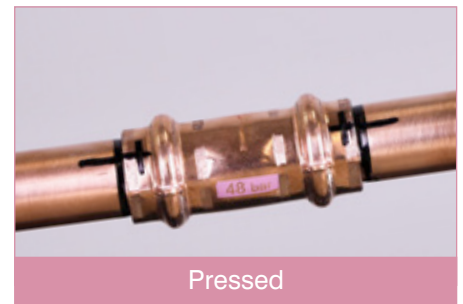
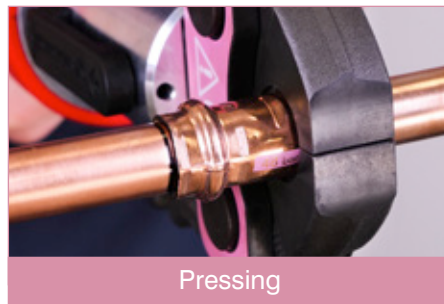

4.0 Technical Data

Technical Data	
Parameters	Capability
Applications	Air conditioning, refrigeration, heat pump (refrigerant side)
Connections	Copper to copper
Approved tube: Copper tube conforming to*	ASTM-B280 or ASTM-B88 type K or L
Fitting / tube range	1/4", 3/8", 1/2", 5/8", 3/4", 7/8", 1", 1 1/8"
Fitting material	Refrigerant grade copper (UNS C12200 min 99.9% pure)
O-ring	HNBR
Approved oils	POE, PAO, PVE, AB and MO
Maximum operating and abnormal pressure	700 psi / 48 bar / 4800 kPa
Burst pressure > 3 x maximum operating and abnormal pressure	>2100 psig / >14400 kPa / >144 bar
Leak tightness	Helium $\leq 7.5 \times 10^{-7}$ Pa.m ³ /s at +20 °C, 10 bar
Vacuum	200 microns
O-ring temperature range	-40 °F to 284 °F / -40 °C to 140 °C
UL listing continuous operating temperature	-40 °F to 250 °F / -40 °C to 121 °C
Compatible refrigerants	R-1234yf**, R-1234ze**, R-125, R-134a, R-290**, R-32**, R-404A, R-407A, R-407C, R-407F, R-407H, R-410A, R-417A, R-421A, R-422B, R-422D, R-427A, R-438A, R-444A**, R-447A**, R-447B**, R-448A, R-449A, R-450A, R-452A, R-452B**, R-452C, R-454A**, R-454B**, R-454C**, R-457A**, R-459A**, R-507A, R-513A, R-513B, R-600A**, R-718 and HYCOOL 20.

*Please refer to >B< MaxiPro Tube Compatibility Table, see section 12.10.

** When using refrigerants classified A2L (lower flammability), A2 (flammable) and A3 (higher flammability) additional/specific standards, local rules and regulations, codes of practice and by-laws may be applicable.

Note: >B< MaxiPro fittings are NOT suitable for R-717, R-723, R-764, R-744 refrigerants. Please check our website www.conexbanninger.com/bmaxipro for updates on the >B< MaxiPro range.

5.0 Quality Assurance

Conex Bänninger is an ISO 9001 quality assured company. We are committed to providing quality products and support to our customers.

6.0 Trademarks and Patents

>B< MaxiPro is a registered trademark in numerous territories worldwide. For information on >B< MaxiPro patents visit www.conexbanninger.com/bmaxipro

7.0 Size Availability

>B< MaxiPro is available in the following sizes 1/4", 3/8", 1/2", 5/8", 3/4", 7/8", 1", 1 1/8". For more information see range details.

8.0 Fitting Material

>B< MaxiPro is manufactured from refrigerant grade copper (UNS C12200 min 99.9% pure).

9.0 Approvals, Standards and Code Compliance

- UL Listed. Refrigerant fitting SA44668.
- UL Listed: Approved use for Field and Factory installations.
- UL 109 - 7 Pull test, compliant.
- UL 109 - 8 Vibration test, compliant.
- UL 1963 - 79 Tests of gaskets and seals used in refrigerant systems, compliant.
- ISO 5149-2:2014, Refrigerating systems and heat pumps - Safety and environmental requirements - Part 2: Design, construction, testing, marking and documentation compliant.
- ISO 5149-2, 5.3.2.2.3 Strength pressure test, compliant.
- ISO 14903 - 7.4 Tightness test, compliant.
- ISO 14903 - 7.6 Pressure temperature vibration tests (PTV), compliant.
- ISO 14903 - 7.8 Freezing test, compliant.
- ASTM G85 salt spray (fog) compliant.
- ASHRAE 15 - 2016 Safety Standard for Refrigeration Systems, compliant.
- ASME B31.5 - 2016 Refrigeration Piping and Heat Transfer Components, compliant.
- 2018, 2015, 2012, 2009 and 2006 International Mechanical Code (IMC), certified, ICC-ES, PMG-1440.
- 2018, 2015, 2012, 2009 and 2006 International Residential Code (IRC), certified, ICC-ES, PMG-1440.
- 2018, 2015, 2012, 2009 and 2006 Uniform Mechanical Code (UMC), certified, ICC-ES, PMG-1440.

Mechanical joints shall not be used on annealed temper copper tube in sizes larger than 7/8 inch (22.2 mm) OD size per International Mechanical Code (IMC) and 3/4 inch nominal size per Uniform Mechanical Code (UMC).

10.0 Fittings Storage

>B< MaxiPro fittings do not require special storage conditions. However to protect the HNBR O-ring a few simple precautions should be taken.

The O-rings should be protected from light sources, in particular direct sunlight or intense artificial light having a high ultra-violet content.

As the ozone is particularly harmful to rubber, storage rooms should not contain any equipment that is capable of generating ozone, such as mercury vapor lamps or high-voltage electrical equipment giving rise to electric sparks or silent electrical discharges.

Combustion gases and organic vapors should be excluded from storage rooms, as they may give rise to ozone via photochemical processes. Precautions should also be taken to protect stored products from all sources of ionizing radiation.

>B< MaxiPro fittings should be kept in their sealed bags to protect them from contamination.

11.0 Marking and Cleanliness

Each fitting is marked >B< MaxiPro, size and 48 bar (on a pink background) and are cleaned, bagged and labeled to fully comply with the cleanliness requirements of ASTM-B280 and ASTM-B88 type K or L. Keep the ziplock bag sealed to protect fittings from contamination.

12.0 Design Considerations

All refrigeration pipelines must be designed so that the number of joints is kept to a practical minimum. Refrigeration pipelines should be designed in compliance with the following key standards and in line with federal, state and local regulations, codes of practice and by-laws governing the installation. All applicable health and safety practices must be adhered to.

- ASHRAE 15 - 2016 Safety Standard for Refrigeration Systems.
- ASME B31.5 - 2016 Refrigeration Piping and Heat Transfer Components.
- 2018, 2015, 2012, 2009 and 2006 International Mechanical Code (IMC).
- 2018, 2015, 2012, 2009 and 2006 International Residential Code (IRC) .
- 2018, 2015, 2012, 2009 and 2006 Uniform Mechanical Code (UMC).

12.1 Pipework support

All pipework should be supported by the use of appropriate clips, brackets or supports. Please refer to:

- ASHRAE 15 - 2016 Safety Standard for Refrigeration Systems.
- ASME B31.5 - 2016 Refrigeration Piping and Heat Transfer Components.
- 2018, 2015, 2012, 2009 and 2006 International Mechanical Code (IMC).
- 2018, 2015, 2012, 2009 and 2006 International Residential Code (IRC).
- 2018, 2015, 2012, 2009 and 2006 Uniform Mechanical Code (UMC).

Federal, state and local regulations, codes of practice and by-laws governing the installation must also be adhered to. Supports should be placed near to fittings when possible and additional supports may be required when using soft copper tubes or where vibration occurs.

12.2 Pipework protection

Tubing and fittings shall be protected as far as possible against adverse environmental or other external effects. Refer to:

- ASHRAE 15 - 2016 Safety Standard for Refrigeration Systems.
- ASME B31.5 - 2016 Refrigeration Piping and Heat Transfer Components.
- 2018, 2015, 2012, 2009 and 2006 International Mechanical Code (IMC).
- 2018, 2015, 2012, 2009 and 2006 International Residential Code (IRC).
- 2018, 2015, 2012, 2009 and 2006 Uniform Mechanical Code (UMC).

Federal, state and local regulations, codes of practice and by-laws governing the installation must also be adhered to.

12.3 Pipework identification and insulation

All pipework must be installed in accordance with:

- ASHRAE 15 - 2016 Safety Standard for Refrigeration Systems.

12.4 Electrical continuity

>B< MaxiPro fittings maintain ground continuity without the need for additional ground continuity straps.

12.5 Space required for the pressing process

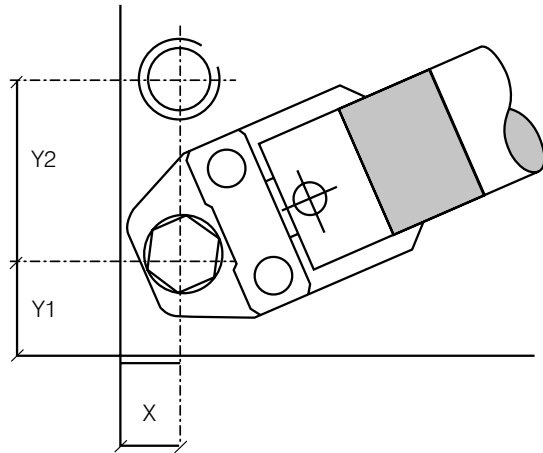
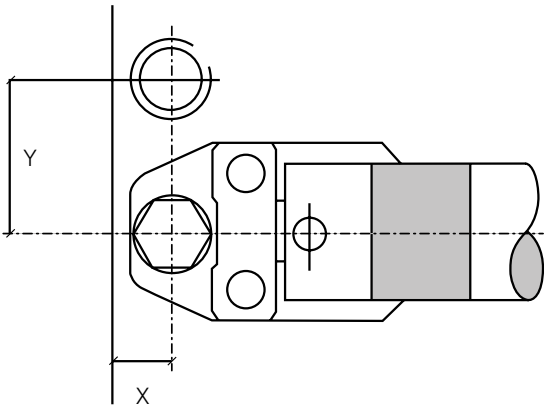

Space required for completing a pressing between tubes and wall ROTHENBERGER ROMAX 4000				
Tube size OD	X	X	Y	Y
Inches	mm	Inches	mm	Inches
1/4"	30	1 1/4"	60	2 3/8"
3/8"	30	1 1/4"	60	2 3/8"
1/2"	30	1 1/4"	60	2 3/8"
5/8"	30	1 1/4"	60	2 3/8"
3/4"	30	1 1/4"	60	2 3/8"
7/8"	35	1 3/8"	60	2 3/8"
1"	35	1 3/8"	60	2 3/8"
1 1/8"	35	1 3/8"	60	2 3/8"

Space required for completing a pressing between tubes and wall corner ROTHENBERGER ROMAX 4000						
Tube size OD	X	X	Y1	Y1	Y2	Y2
Inches	mm	Inches	mm	Inches	mm	Inches
1/4"	50	2"	50	2"	100	4"
3/8"	50	2"	50	2"	100	4"
1/2"	50	2"	50	2"	110	4 3/8"
5/8"	50	2"	50	2"	110	4 3/8"
3/4"	50	2"	50	2"	110	4 3/8"
7/8"	60	2 3/8"	60	2 3/8"	120	4 3/4"
1"	60	2 3/8"	60	2 3/8"	120	4 3/4"
1 1/8"	60	2 3/8"	60	2 3/8"	120	4 3/4"

Space required for completing a pressing between tubes and wall ROTHENBERGER ROMAX TT US				
Tube size OD	X	X	Y	Y
Inches	mm	Inches	mm	Inches
1/4"	30	1 1/4"	55	2 3/16"
3/8"	30	1 1/4"	55	2 3/16"
1/2"	25	1"	55	2 3/16"
5/8"	25	1"	55	2 3/16"
3/4"	25	1"	55	2 3/16"
7/8"	30	1 1/4"	55	2 3/16"
1"	30	1 1/4"	55	2 3/16"
1 1/8"	35	1 3/8"	55	2 3/16"

Space required for completing a pressing between tubes and wall corner ROTHENBERGER ROMAX TT US						
Tube size OD	X	X	Y1	Y1	Y2	Y2
Inches	mm	Inches	mm	Inches	mm	Inches
1/4"	40	1 5/8"	40	1 5/8"	100	4"
3/8"	40	1 5/8"	40	1 5/8"	105	4 1/4"
1/2"	40	1 5/8"	40	1 5/8"	105	4 1/4"
5/8"	40	1 5/8"	40	1 5/8"	105	4 1/4"
3/4"	40	1 5/8"	40	1 5/8"	105	4 1/4"
7/8"	55	2 3/16"	55	2 3/16"	110	4 3/8"
1"	60	2 3/8"	60	2 3/8"	115	4 9/16"
1 1/8"	60	2 3/8"	60	2 3/8"	115	4 9/16"

12.6 Insertion depth and minimum distances between pressings

Due to the reforming of the tube profile when pressed, it is advised that a minimum distance is allowed between each fitting.

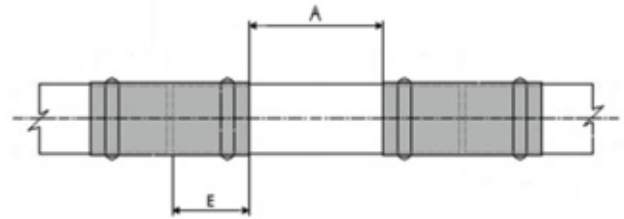

Nominal size inches	Minimum distance A mm	Minimum distance A inches	Insertion depth E mm	Insertion depth E inches
1/4"	10	1/2"	18.0	0.71
3/8"	10	1/2"	18.0	0.71
1/2"	15	5/8"	19.0	0.75
5/8"	15	5/8"	22.0	0.87
3/4"	20	7/8"	23.0	0.91
7/8"	20	7/8"	25.0	0.98
1"	25	1"	24.0	0.94
1 1/8"	25	1"	26.5	1.04

12.7 Minimum distance for press fittings from an existing brazed joint

To ensure proper sealing of both the brazed and >B< MaxiPro fitting the following minimum distances must be maintained between the two fittings.

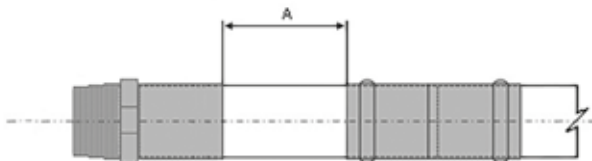

Minimum distance from a brazed joint		
Nominal size tube OD	Minimum distance A	Minimum distance A
Inches	mm	Inches
1/4"	10	1/2"
3/8"	10	1/2"
1/2"	15	5/8"
5/8"	15	5/8"
3/4"	20	7/8"
7/8"	20	7/8"
1"	25	1"
1 1/8"	25	1"

Note: A - clearance between fitting ends

It is important that there is no residual brazing or other foreign debris on the tubing to be inserted into the >B< MaxiPro fitting. The surface condition on the area of press joint should be clean and free from debris and comply with ASTM-B280 or ASTM-B88 type K or L.

12.8 Minimum brazing distance to an existing pressed fitting

Caution – Brazing near to >B< MaxiPro joints should be avoided as this may cause the seal to degrade due to heat transfer. The table below states the minimum distance away from the press joint which is acceptable to braze. If this distance cannot be maintained then adequate precautions must be taken such as fabricating the brazed section prior to assembly with the press fittings, wrapping in a wet rag or applying a heat barrier spray, gel or putty, to prevent heat transfer to the press fitting during brazing.

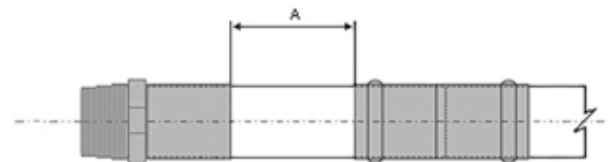

Minimum distance brazing		
Nominal size tube OD	Minimum distance A	Minimum distance A
Inches	mm	Inches
1/4"	250	10"
3/8"	300	12"
1/2"	350	13 3/4"
5/8"	450	17 3/4"
3/4"	500	19 3/4"
7/8"	600	23 3/4"
1"	650	24 1/2"
1 1/8"	700	27 1/2"

Note: A - clearance between fitting ends

12.9 Testing and commissioning of air conditioning and refrigeration systems

Testing and commissioning of air conditioning and refrigeration systems should be in accordance with the requirements specified in:

- ASHRAE 15 - 2016 Safety Standard for Refrigeration Systems.
- ASME B31.5 - 2016 Refrigeration Piping and Heat Transfer Components.
- 2018, 2015, 2012, 2009 and 2006 International Mechanical Code (IMC).
- 2018, 2015, 2012, 2009 and 2006 Uniform Mechanical Code (UMC).

Federal state and local regulations, codes of practice and by-laws governing the installation must also be adhered to.

General

- Dry oxygen free nitrogen (OFN) should be used for tightness and strength testing as it is inert. Do not use oxygen for pressure testing, under pressure it can react violently with hydrocarbons (oil and grease) resulting in explosions and fire.
- The maximum test pressure to be identified by the installer. This will be calculated from the system pressure and the test parameters.
- To ensure >B< MaxiPro fittings are tested safely, during the strength pressure and / or tightness test, the pressure should be raised gradually up to the desired test pressure of the system as established by the installer.

- If you are going to leave the pipework pressurized for 24 hours or longer to check for leaks, measure the system pressure and the ambient temperature at the start and finish of the tightness test. A rise in ambient temperature can mask a leak if this is not taken into account. There will be a pressure change of approximately 10 psi with a temperature change of 9 °F.
- Care must be taken to ensure a >B< MaxiPro joint will not be close enough to the liquid charging point that the temperature of the joint drops below -40 °F when breaking a vacuum by liquid charging the system.

Problem Solving Vacuum Evacuation

Vacuum evacuation removes air, moisture, and non-condensable gases prior to system charging.

Failure to achieve a vacuum:

- A leak or moisture in the system (see below).
- Vacuum pump not working correctly.
- Vacuum pump does not have sufficient capacity.

Failure to hold a vacuum:

- A leak in the system or the connections to the system – find all leaks and repair them.
 - An ultrasonic leak detector can help pinpoint leaks on a system under vacuum.
- Moisture or refrigerant still in the system – continue evacuation.

No remedial action e.g. cutting out fittings from the system should be taken until a proper fault finding exercise has been completed.

12.10 >B< MaxiPro tube compatibility table

>B< MaxiPro fitting size	Tube size Nominal OD		ASTM B280 - ASTM B88									
			Wall thickness									
	Inch	mm	0.025"	0.030"	0.031"	0.035"	0.040"	0.042"	0.045"	0.049"	0.050"	0.065"
	Inch	mm	0.64	0.76	0.81	0.89	1.02	1.07	1.14	1.24	1.27	1.65
1/4"	0.250"	6.35	● ■	● ■								
3/8"	0.375"	9.53		● ■	● ■	● ■						
1/2"	0.500"	12.70			● ■	● ■				● ■		
5/8"	0.625"	15.88				● ■	● ■		■	● ■		
3/4"	0.750"	19.05				● ■		● ■		● ■		
7/8"	0.875"	22.23				●			● ■			● ● ■
1 1/8"	1.125"	28.58				●	●				● ■	■

- Annealed coil
- Straight tube Half hard / Hard

Notes:

Hardness tolerance as per approved standards in the table above.

Ensure coil tubes are in round condition. Oval tubes should be re-rounded.

It is the engineer's responsibility to ensure that the tube selected is compatible with >B< MaxiPro and meets the operating pressure requirements of the system.

13.0 >B< MaxiPro Installation

General: Conex Bänninger >B< MaxiPro fittings must be installed by an installer who is appropriately trained and qualified to work on air conditioning and refrigeration installations and certified via the >B< MaxiPro training course. All installations must be completed in line with local regulations and by-laws governing the installation, and all applicable health and safety practices must be adhered to. When using the press tools, care must be taken to ensure hands are kept away from the jaw during the pressing process. Always wear ear and eye protection.

Important: Select the correct size of tube, fitting and jaw for the job. Ensure the fitting and tube are kept free of any dust or dirt and that the O-ring is undamaged. Check the inner pressing contour of the jaw is free of dirt and debris. Do not force tube ends together prior to making joints. Joints should only be made on an unstressed pipework assembly.

Remarks:

- A joint is finished after one complete compression cycle of the tool.
- Do not press any >B< MaxiPro fitting more than once.

- Pipework alignment must be completed prior to pressing.
- Do not rotate joints after they have been pressed.

Copper tube compatibility: Please refer to tube compatibility table, section 12.10.

Maximum operating pressure: 700 psi, 48 bar, 4,800 kPa.

Operating temperature range: -40 °F to 250 °F, -40°C to 121°C.

Compatible refrigerants: R-1234yf**, R-1234ze**, R-125, R-134a, R-290**, R-32**, R-404A, R-407A, R-407C, R-407F, R-407H, R-410A, R-417A, R-421A, R-422B, R-422D, R-427A, R-438A, R-444A**, R-447A**, R-447B**, R-448A, R-449A, R-450A, R-452A, R-452B**, R-452C, R-454A**, R-454B**, R-454C**, R-457A**, R-459A**, R-507A, R-513A, R-513B, R-600A**, R-718 and HYCOOL 20.

** When using refrigerants classified A2L (lower flammability), A2 (flammable) and A3 (higher flammability) additional/specific standards, local rules and regulations, codes of practice and by-laws may be applicable.

Note: >B< MaxiPro fittings are NOT suitable for R-717, R-723, R-764, R-744 refrigerants.

Compatible oils: POE, PAO, PVE, AB and MO.





1. Cut the tube to length

- Use a rotary tube cutter.
- Ensure that the tube is cut square.
- Check the tube has retained its shape and is damage free.

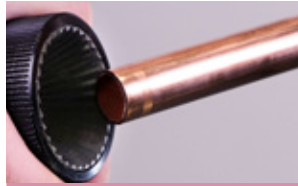

2. Deburr and remove all external sharp edges

- Deburr the tube both internally and externally.
- Where possible angle the tube downwards to prevent filings entering the tube.
- Use a pencil type deburrer on internal tube edges.
- Make sure the internal and external surfaces of the tube ends are smooth and free from burrs or sharp edges.



3. Use a pencil type deburrer on internal edges



4. Clean the tube end

- Thoroughly clean the tube end using ROTHENBERGER ROVLIES or similar cleaning pad in a rotating action.
- Tube ends must be free from scratches, oxidation, dirt and debris.



5. Check for defects

- If deep scratches are still visible, cut the tube back to a clean section.



6. Ensure the O-ring is seated

- Check the fitting is the correct size for the tube.
- Check the O-rings are present and correctly seated.
- A small additional amount of Conex Bänninger press fitting lubricant may be used to aid tube insertion.



7A. Mark insertion depth on tube using depth gauge

- Insert tube into correct socket in depth gauge.
- Check window to see the tube is fully inserted.
- Mark the insertion depth on the tube.



7B. Alternatively insert tube to tube stop and mark

- The tube must be fully inserted into the fitting until it reaches the tube stop.
- To reduce the risk of dislodging the O-ring rotate the tube (if possible) while slipping it into the fitting.
- Mark the insertion depth on the tube.

10



7B. Check the depth mark

- Remove the tube and align with fitting socket, check that the depth mark is correctly positioned.
- The insertion depth mark is used as a reference prior to pressing the joint.



8. Insert the tube fully into the fitting. Ensure tube is fully inserted prior to pressing

- Insert the tube fully into the fitting up to the tube stop.
- To reduce the risk of dislodging the O-ring rotate the tube (if possible) while slipping it into the fitting.
- Prior to pressing, ensure the tube has not moved out from the fitting socket.
- Use the insertion depth mark as a guide.



9. Align jaws squarely on the fitting

- Ensure pipework is correctly aligned prior to pressing.
- Ensure the correct size jaw is inserted into the tool.
- The jaws must be placed squarely on the fitting locating the groove on the bead.
- The bead on the fitting should fit centrally in the groove of the jaw.



10. Complete the joint with the approved tool. Press once only

- Depress and hold the button to complete the pressing cycle.
- Pressing is complete when the jaws are fully closed and the piston retracts.
- Complete the press cycle once only – do not repress.
- Release the jaws from the pressing.



11. Mark the completed joint

- Mark the completed joint after pressing.
- This enables joints to be inspected easily before testing and insulating the pipework.



>B< MaxiPro home page

- Use QR code app on your smart phone or tablet to access >B< MaxiPro home page.

Installing a >B< MaxiPro female flare connector to a male flare connector.

Make the flare connection prior to pressing the >B< MaxiPro joint. If this is not possible care must be taken to prevent rotational forces being applied to the pressed joint.

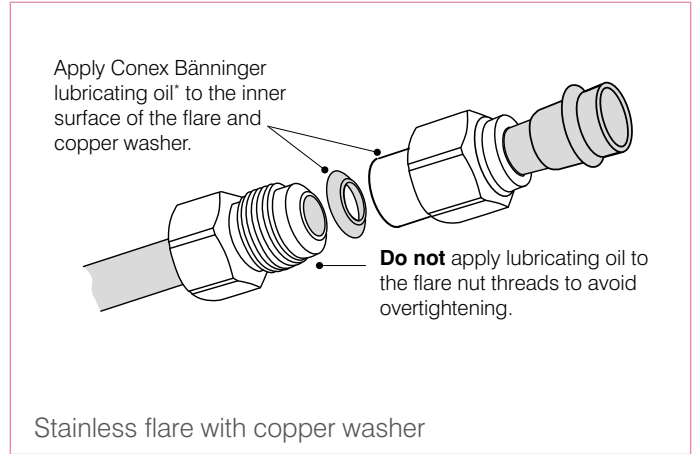
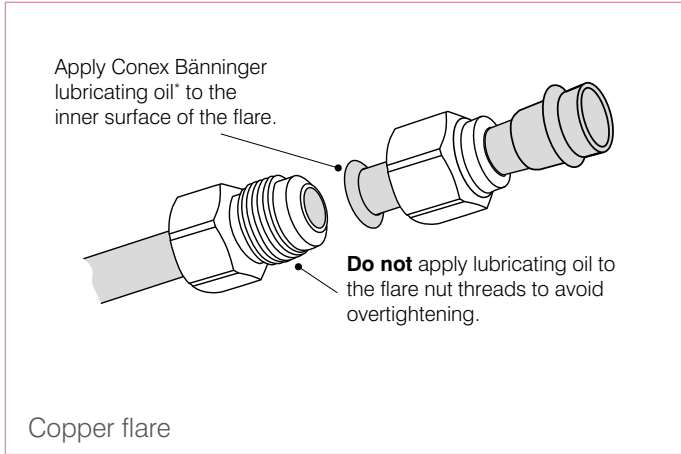

Align the centers of both flares and tighten the flares by hand.

***Note:** A compatible refrigerant oil may be used if Conex Bänninger lubricating oil is not available.

Align the centers of both flares and tighten the flares by hand.

***Note:** A compatible refrigerant oil may be used if Conex Bänninger lubricating oil is not available.

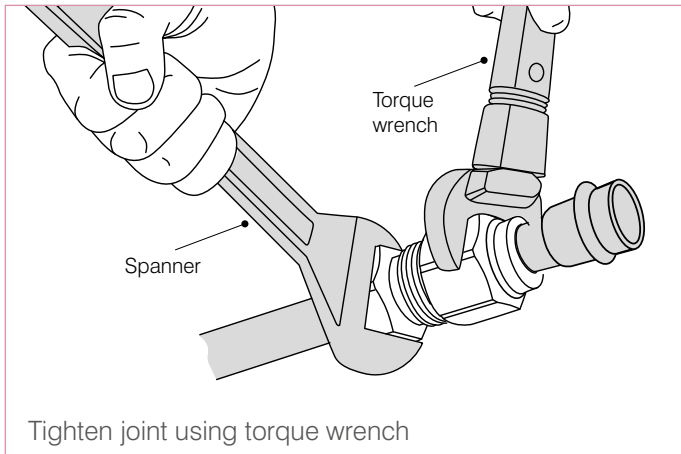

Fully tighten using spanner and torque wrench to the torque values set out in the table. **Do not over tighten.**

Flares Tightening Torque		
Size	N m	ft lbf
1/4"	14-18	11-13
3/8"	33-42	25-31
1/2"	50-62	37-45
5/8"	63-77	47-56
3/4"	90-110	67-81
Do not over tighten		

14.0 Frequently Asked Questions

1. How long is the Conex Bänninger business heritage?

Since 1909.

2. Where are the >B< MaxiPro fittings manufactured?

The products are manufactured in Europe.

3. Does >B< MaxiPro work on both hard and soft copper?

Yes, >B< MaxiPro is a press fitting system for use with hard, half hard or annealed copper tube conforming to ASTM-B280 or ASTM-B88 type K or L. Mechanical joints shall not be used on annealed temper copper tube in sizes larger than 7/8 inch (22.2 mm) OD size per International Mechanical Code IMC and 3/4 inch nominal size per Uniform Mechanical Code (UMC).

*Please refer to >B< MaxiPro - Tube Compatibility Table, see section 12.10.

4. Can you use >B< MaxiPro to press to aluminium, steel, or stainless steel?

No, >B< MaxiPro is specifically designed for copper to copper connections. Connecting to dissimilar metals can cause corrosion issues that could cause a failure.

5. What is the warranty on >B< MaxiPro fittings?

The product has a five year limited warranty. Please refer to full warranty terms see section 18.0.

6. What material is the O-ring made of?

The O-ring is manufactured from Hydrogenated Nitrile Butadiene Rubber (HNBR).

7. What is the expected life of the O-ring in the system?

The O-ring is manufactured by Germany's leading producer of O-rings. The expected life of the O-ring if used within the product specifications for temperature and pressure is at least 25 years.

8. Are there any storage issues, including where the fittings are stored in vehicles and exposed to extremes of high or low temperature?

No, the product is not subject to degradation under normal storage conditions. Provided it is kept in original packaging and not exposed to direct sunlight for long periods. Please see section 10.0 for details regarding fitting storage.

9. What refrigerants are compatible with >B< MaxiPro?

>B< MaxiPro is compatible for use with R-1234yf**, R-1234ze**, R-125, R-134a, R-290**, R-32**, R-404A, R-407A, R-407C, R-407F, R-407H, R-410A, R-417A, R-421A, R-422B, R-422D, R-427A, R-438A, R-444A**, R-447A**, R-447B**, R-448A, R-449A, R-450A, R-452A, R-452B**, R-452C, R-454A**, R-454B**, R-454C**, R-457A**, R-459A**, R-507A, R-513A, R-513B, R-600A**, R-718 and HYCOOL 20.

** When using refrigerants classified A2L (lower flammability), A2 (flammable) and A3 (higher flammability) additional/specific standards, local rules and regulations, codes of practice and by-laws may be applicable.

Note: >B< MaxiPro fittings are NOT suitable for R-717, R-723, R-764, R-744 refrigerants.

Please check our website www.conexbanninger.com/bmaxipro for updates on the >B< MaxiPro range.

10. What oils are approved for use with >B< MaxiPro?

>B< MaxiPro is approved for use with POE, PVE, PAO, AB and MO. The O-ring has been tested successfully with PAG oil however PAG oil should not be used with copper systems due to potential for corrosion of the copper material.

11. If a fitting leaks on installation, can you braze the fitting rather than cutting out the joint and having to replace missing tube?

No, if a fitting that has been pressed is leaking, the fitting must be cut out and replaced. You should not attempt to braze the fitting as you may melt the O-ring material and thus introduce contaminants into the system that could cause other system issues.

12. Is there a concern about ice building up and then thawing under the fitting in a horizontal or vertical configuration?

No, >B< MaxiPro has been thoroughly freeze / thaw tested. ISO 14903 - Freeze / thaw test, compliant.

13. Are there any concerns with corrosion where installations are made in coastal areas or with respect to cleaning agents?

No, >B< MaxiPro has been Acid Salt Spray tested to ASTM G85. As with all copper installations exposure to ammonia should be avoided.

14. How do you know when the press tool needs to be serviced?

The tools service counter keeps a record of the number of pressings. The LED flashes after 40,000 pressings indicating service required.

15. Do >B< MaxiPro Jaws need servicing?

>B< MaxiPro jaws are laser hardened and do not require servicing.

16. Are the >B< MaxiPro jaws compatible with any other commercially available press tool?

Please see section 15.0 Press Tools and Jaws.

17. What tube diameter is acceptable if a press joint is going to be made with >B< MaxiPro ?

>B< MaxiPro is a press fitting system for use with hard, half hard or annealed copper tube conforming to ASTM-B280 ASTM-B88 type K or L. Mechanical joints shall not be used on annealed temper copper tube in sizes larger than 7/8 inch (22.2 mm) OD size per International Mechanical Code IMC and 3/4 inch nominal size per Uniform Mechanical Code (UMC).

*Please refer to >B< MaxiPro - Tube Compatibility Table, see section 12.10.

18. What standards and codes is >B< MaxiPro compliant with and what approvals does it hold?

UL Listed. Refrigerant fitting SA44668.
 UL Listed: Approved use for Field and Factory installations.
 UL 109 - 7 Pull test, compliant.
 UL 109 - 8 Vibration test, compliant.
 UL 1963 - 79 Tests of Gaskets and Seals Used in Refrigerant Systems, compliant.
 ISO 5149-2:2014, Refrigerating systems and heat pumps - Safety and environmental requirements - Part 2: Design, construction, testing, marking and documentation, compliant.
 ISO 5149-2 - 5.3.2.2.3 Strength pressure test, compliant.
 ISO 14903 - 7.4, Tightness test, compliant.
 ISO 14903 - 7.6 Pressure temperature vibration tests (PTV), compliant.
 ISO 14903 - 7.8 Freezing test, compliant.
 ASTM G85 -11, Standard Practice for Modified Salt Spray (Fog) Testing, compliant.
 ASHRAE 15 - 2016 Safety Standard for Refrigeration Systems, compliant.
 ASME B31.5 - 2016 Refrigeration Piping and Heat Transfer Components, compliant.
 2018, 2015 - 2012, 2009 and 2006 International Mechanical Code (IMC), certified, ICC-ES, PMG-1440.
 2018, 2015, 2012, 2009 and 2006 International Residential Code (IRC), certified, ICC-ES, PMG-1440.
 2018, 2015, 2012, 2009 and 2006 Uniform Mechanical Code (UMC), certified, ICC-ES, PMG-1440.

19. Does the O-ring compensate for imperfections in the tube to make a tight seal?

Yes, the O-ring does compensate for small/minor scratches on the surface of the tube. However imperfections adjacent to the press area such as scratches and tubing that is not round must be avoided.

20. The product specifications state that the application temperature limits are -40 °F to 250 °F. What happens if we go beyond that limit?

>B< MaxiPro is suitable for continuous operating at temperatures between -40 and +250 °F. It will also cope with short term excursions up to 284 °F. Operating at temperatures outside this range is not acceptable and may lead to failure.

21. How clean are >B< MaxiPro fittings?

>B< MaxiPro fittings comply with the cleanliness standard as required in the following Copper Tube Standards ASTM-B280. Keep the ziplock bag sealed to protect fittings from contamination.

22. How do the fittings cope with vibration from the system?

Vibration is a recognized cause of leaks and the system must be designed and installed to comply with all local standards and codes of practice which aim to minimise vibration.

>B< MaxiPro fittings have been extensively tested to ensure the joint will not leak as a result of system vibration and complies with the following standards:

- ISO 14903 temperature, pressure cycling and vibration test
- UL 109-8 vibration
- UL 207 fatigue shock test

23. Will the O-ring be damaged if acid develops in the refrigeration system?

Good piping practice, a nitrogen purge during any brazing (not required with >B< MaxiPro mechanical fittings), a deep evacuation, and the proper installation and use of filter-driers containing modern and effective molecular sieve desiccants will prevent many system failures. Including the build up of acid within the system.

When selecting which desiccant material is best for an application, water capacity, refrigerant and lubricant compatibility, acid capacity, and physical strength are important characteristics and should be considered.

24. When pressed, small size fittings, particularly elbows, may allow a small amount of rotational movement to be induced at the joint. Will this affect the security of the joint?

No, some rotational movement is quite acceptable, the joint will not leak nor will it come apart under the pressure loading and during system operation. Some joint movement is good as it will allow for expansion and contraction in the pipework system.

25. Is >B< MaxiPro suitable for medical gas applications?

No, >B< MaxiPro is not suitable for medical gas applications.

26. Can you press a fitting more than once?

No, >B< MaxiPro fittings can be pressed only once.

27. Is >B< MaxiPro approved for drinking water systems?

No, >B< MaxiPro is not approved for drinking water systems.

28. Can >B< MaxiPro be used on heating and hot water systems?

No, >B< MaxiPro is approved for use in air conditioning and refrigeration applications only.

29. If my system fails to achieve or hold a vacuum what should I do?

Problem Solving Vacuum Evacuation

Vacuum evacuation removes air, moisture, and non-condensable gases prior to system charging.

Failure to achieve a vacuum:

- A leak or moisture in the system (see below).
- Vacuum pump not working correctly.
- Vacuum pump does not have sufficient capacity.

Failure to hold a vacuum:

- A leak in the system or the connections to the system – find all leaks and repair them.
- An ultrasonic leak detector can help pinpoint leaks on a system under vacuum.
- Moisture or refrigerant still in the system – continue evacuation.

No remedial action e.g. cutting out fittings from the system should be taken until a proper fault finding exercise has been completed.

30. I am having a problem achieving a seal on a flared connection what should I do?

If you cannot achieve a seal on a flared connection, place a small drop of Conex Bänninger press fitting lubricant on the sealing face.

15.0 Press Tools and Jaws

Conex Bänninger recommends the use of ROTHENBERGER press tools and jaws.

Only ROTHENBERGER jaws are approved for use with >B< MaxiPro fittings.

15.1 ROTHENBERGER ROMAX 4000



Specification ROTHENBERGER ROMAX 4000

Battery voltage – 18.0 V

Battery capacity – 2.0 Ah / 4.0 Ah

Rated power consumption – 540 Watts

Max piston force – 7,193 lbf / 32 kN

Pressing time – 5 secs (nominal)

Dimensions (LxWxH) – 17 3/4" x 5" x 3 1/4" / 450 x 125 x 79 mm

Weight (less battery) – 6.4 lb / 2.9 kg

Working range: Copper system 1/4" – 4"

Typical A-rate noise level – 85 dB(A)

Battery charging time (90% full) – ca. 40 / 80 min.

Approximate pressings per full charge – 240

Note: When using the tool wear ear and eye protection.

- Application sizes: 1/4" to 1 1/8" >B< MaxiPro fittings
- Light weight and balanced weight distribution, fatigue free operation over long periods.
- Constant Force Technology (CFT®), for constant axial pressing force of 7,193 lbf.
- Simple and safe operation, press and hold start button – tool automatically stops after press cycle is complete, piston retracts.
- Pressing cycle less than 5 seconds.
- Yellow emergency stop button, immediate interruption of the press cycle and retraction of the piston.
- Safety lock, ensures the jaw cannot come out during operation.
- Press jaw fixture can be rotated by 360° for easy operation in confined spaces.
- Expanded service interval of 40,000 cycles.
- The service counter records the number of pressings. After 40,000 pressings the white LEDs that illuminate the work area flash at the end of every pressing cycle indicating that service is due. The tool continues to operate but should be serviced at the earliest opportunity.
- Li-ion battery with charge indicator.
- Powerful long lasting 18 V / 4.0 Ah or 2.0 Ah battery, with charge indicator. Up to 240 presses with 4.0 Ah battery.

>B< MaxiPro tool compatibility table – 32 kN press tool and jaws

Approved >B< MaxiPro 32 kN press jaws		
Size	Manufacturer	Serial No.
1/4"	ROTHENBERGER	1000001889
3/8"	ROTHENBERGER	1000001890
1/2"	ROTHENBERGER	1000001891
5/8"	ROTHENBERGER	1000001892
3/4"	ROTHENBERGER	1000001893
7/8"	ROTHENBERGER	1000001894
1"	ROTHENBERGER	1000001895
1 1/8"	ROTHENBERGER	1000001896

Compatible 32 kN press tools		
Manufacturer	Model	Compatible
ROTHENBERGER	ROMAX® 3000	✓
ROTHENBERGER	ROMAX® 3000 AC	✓
ROTHENBERGER	ROMAX® 4000	✓
ROTHENBERGER	ROMAX® AC ECO	✓
DEWALT	DCE200	✓
KLAUKE	UAP2/UNP2	✓
KLAUKE	UAP3L/UAP4L	✓
KLAUKE	UP2EL14	✓
MILWAUKEE	M18 Force Logic	✓
NIBCO	PC-100	✓
NIBCO	PC-280	✓
REMS	Power-Press	✓
REMS	Akku-Press	✓
RIDGID	320-E	✓
RIDGID	CT400	✓
RIDGID	RP 330-B	✓
RIDGID	RP 330-C	✓
RIDGID	RP 340	✓
VIRAX	Viper® P25+	✓
VIRAX	Viper® P30+	✓

32kN press tool and jaws

Approved >B< MaxiPro 32 kN press jaw sets		
Size	Manufacturer	Serial No.
1/4 – 1 1/8"	ROTHENBERGER 8 jaw set	1000002207
1/4 – 7/8" & 1 1/8"	ROTHENBERGER 7 jaw set	1000002206

>B< MaxiPro fittings are only compatible with ROTHENBERGER press jaws as shown in the table above.

Conex Bänninger recommends the use of ROTHENBERGER 32 kN press tools in combination with >B< MaxiPro jaws. However other 32 kN press tools may be used in combination with ROTHENBERGER >B< MaxiPro jaws. See table to the right for tool compatibility.

15.2 ROTHENBERGER ROMAX TT US



Specification ROTHENBERGER ROMAX TT US

Battery voltage – 18 V

Battery capacity – 2.0 Ah / 4.0 Ah / 8.0 Ah

Rated power consumption – 281 Watts

Max piston force – 5,395 lbf / 24 kN

Pressing time - ca. 3 secs (nominal)

Dimensions (L x W x H) – 13.23 x 5.63 x 3.0 inches / 336 x 143 x 76 mm

Weight (less battery) - ca. 4.63 lb / 2.1 kg

Working range: Copper system 1/4" – 1 1/8"

The noise level during operation can exceed 85 dB (A). Wear hearing protection

Battery charging time (90% full) – ca. 40 / 80 / 160 min.

Approximate pressings per full charge – 100 / 140 1 1/8" fittings more from smaller sizes

Note: When using the tool wear ear and eye protection.

- Application sizes: 1/4" to 1 1/8" >B< MaxiPro fittings
- Compact light weight design – single handed operation.
- CFT® - Technology for constant 26 kN pressing force.
- Safety latch to ensure jaw cannot come out during operation.
- Easy to follow LED status indication:
 - Green pressing process can be completed.
 - Red the rechargeable battery is discharged.
 - Flashing red after 40,000 presses indicating that the tool needs servicing.
- Simple and safe operation – hold start button – tool automatically stops once press cycle is complete.
- Integral LED light illuminates work area during and after pressing (approx. 30 secs after end of pressing process).
- Safety yellow button – press to release piston pressure and stop press cycle.
- Convenient 40,000 cycles or 2 year interval (whichever comes first) between service requirements.
- Head positioning up to 270° rotation – easy fitting in difficult locations.
- Li-Ion battery technology – long lasting operation between charges. Battery options 2.0 Ah, 4.0 Ah and 8.0 Ah.

>B< MaxiPro tool compatibility table – 24 kN press tool and jaws

Approved >B< MaxiPro 24 kN press jaws		
Size	Manufacturer	Serial No.
1/4"	ROTHENBERGER	1000002484
3/8"	ROTHENBERGER	1000002485
1/2"	ROTHENBERGER	1000002486
5/8"	ROTHENBERGER	1000002487
3/4"	ROTHENBERGER	1000002488
7/8"	ROTHENBERGER	1000002489
1"	ROTHENBERGER	1000002490
1 1/8"	ROTHENBERGER	1000002491

Compatible 24 kN press tools		
Manufacturer	Model	Compatible
ROTHENBERGER	Twin Turbo US (TT US)	✓
MILWAUKEE	M12	✓
RIDGID	RP 241	✓
RIDGID	RP 240	✓
RIDGID	RP 210-B	✓
RIDGID	RP 200-B	✓

24kN press tool and jaws

Approved >B< MaxiPro 24 kN press jaw set		
Size	Manufacturer	Serial No.
1/4 – 7/8"	ROTHENBERGER 6 jaw set	1000002602

>B< MaxiPro fittings are only compatible with ROTHENBERGER press jaws as shown in the table above.

Conex Bänninger recommends the use of ROTHENBERGER 24 kN press tools in combination with >B< MaxiPro jaws. However other 24 kN press tools with compatible press jaw interface may be used in combination with ROTHENBERGER >B< MaxiPro jaws. See table to the right for tool compatibility.

15.3 ROTHENBERGER customer service

ROTHENBERGER service locations are available to help you (see listing in ROTHENBERGER catalog or online).

Replacement parts and service are also available through these same service locations. Order your accessories and spare parts from your specialist retailer or using ROTHENBERGER'S service-aftersales hotline:

Tel: +1 800-545-76 98 | Fax: +1 815-633-0879

Email: customerservice-us@rothenberger.com

www.rothenberger.com

15.4 ROTHENBERGER warranty coverage

- Tool; 36 months limited warranty against material and manufacturing defects.
- Battery and charger; 12 months limited warranty against material and manufacturing defects.
- Jaws; lifetime limited warranty against material and manufacturing defects.
- If a serial number sticker is damaged, the warranty will be null and void.
- The warranty does not cover damage caused by incorrect use of the equipment.

For tool warranty period and more detailed information please contact your local ROTHENBERGER market organization.

ROTHENBERGER USA LLC. 7130 Clinton Road, IL 61111, Loves Park

Tel: +1 800-545-7698 | Fax: +1 815-633-0879

Email: customerservice-us@rothenberger.com

www.rothenberger.com

16.0 Abbreviations

AB oil	Alkyl Benzene oil.
ASHRAE 15 - 2016	Safety Standard for Refrigeration Systems.
ASTM-B280-13	American Standard Specification for Seamless Copper Tube for Air Conditioning and Refrigeration Field Service.
ASTM-B88 Type K or L	Seamless Copper Water Tube.
ASME B31.5 - 2016 - 2016	Refrigeration Piping and Heat Transfer Components.
CFT	Constant Force Technology.
HNBR	Hydrogenated Nitrile Butadiene Rubber.
IMC 2018	International Mechanical Code 2018.
IRC 2018	International Residential Code 2018.
ISO 5149-2:2014	International Standard for Refrigerating systems and heat pumps - Safety and environmental requirements -- Part 2: Design, construction, testing, marking and documentation.
ISO 9001	Certified quality management system.
ISO 14903:2012	International Standard for Refrigerating systems and heat pumps – Qualification of tightness of components and joints.
LED	Light Emitting Diode.
PAO oil	Poly-alpha-olefin oil.
POE oil	Polyolester oil.
PVE oil	Polyvinylether oil.
SMS	Short Message Service.
UL 207	Standard for Refrigerant-Containing Components and Accessories, Nonelectrical.
UL 1963 – 79	Standard for Refrigerant Recovery / Recycling Equipment. Section 79 Tests of Gaskets and Seals Used in Refrigerant Systems.
UL 109 - 7	Standard for Tube Fittings for Flammable and Combustible Fluids, Refrigeration Service, and Marine Use. Section 7 Pull test.
UL 109 - 8	Standard for Tube Fittings for Flammable and Combustible Fluids, Refrigeration Service, and Marine Use. Section 8 Vibration test.
UMC 2015	Universal Mechanical Code 2015.
UNS	Unified Numbering System.

17.0 >B< MaxiPro Product Range

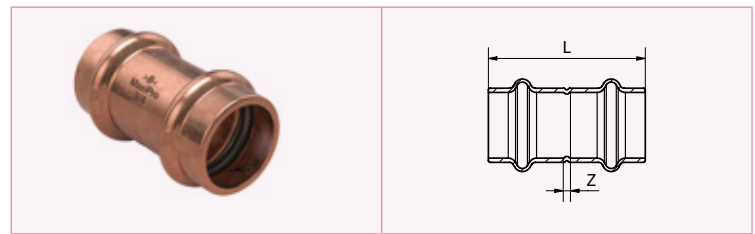

Straight Coupler

Code	Size	L Inch	L mm	Z Inch	Z mm
MPA5270 0020001	1/4"	1.54	39.0	0.12	3.0
MPA5270 0030001	3/8"	1.50	38.0	0.12	3.0
MPA5270 0040001	1/2"	1.57	40.0	0.20	5.0
MPA5270 0050001	5/8"	1.77	45.0	0.12	3.0
MPA5270 0060001	3/4"	1.79	45.5	0.06	1.5
MPA5270 0070001	7/8"	2.22	56.5	0.33	8.5
MPA5270 0080001	1"	1.93	49.0	0.08	2.0
MPA5270 0090001	1 1/8"	2.24	57.0	0.24	6.0

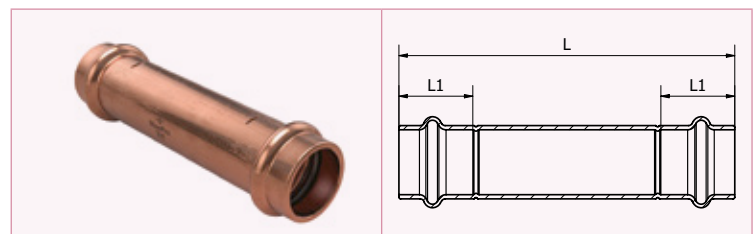

Long Coupler

Code	Size	L Inch	L mm	Z Inch	Z mm
MPA5270L0020001	1/4"	3.54	90.0	0.71	18.0
MPA5270L0030001	3/8"	3.54	90.0	0.71	18.0
MPA5270L0040001	1/2"	3.58	91.0	0.69	17.5
MPA5270L0050001	5/8"	3.98	101.0	0.83	21.0
MPA5270L0060001	3/4"	3.98	101.0	0.86	22.0
MPA5270L0070001	7/8"	4.17	106.0	0.95	24.0
MPA5270L0080001	1"	4.13	105.0	0.93	23.5
MPA5270L0090001	1 1/8"	4.17	106.0	1.00	25.5

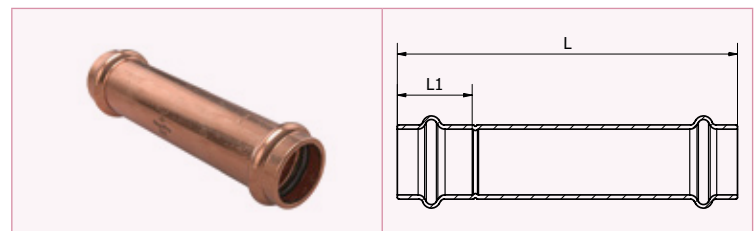

Long Repair Coupler

Code	Size	L Inch	L mm	Z Inch	Z mm
MPA5275L0020001	1/4"	3.54	90.0	0.71	18.0
MPA5275L0030001	3/8"	3.54	90.0	0.71	18.0
MPA5275L0040001	1/2"	3.58	91.0	0.69	17.5
MPA5275L0050001	5/8"	3.98	101.0	0.83	21.0
MPA5275L0060001	3/4"	3.98	101.0	0.86	22.0
MPA5275L0070001	7/8"	4.17	106.0	0.95	24.0
MPA5275L0080001	1"	4.13	105.0	0.93	23.5
MPA5275L0090001	1 1/8"	4.17	106.0	1.00	25.5

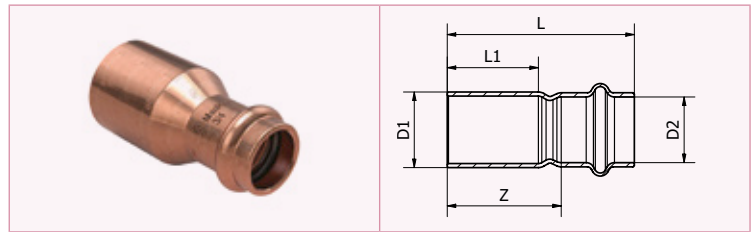

Fitting Reducer

Code	Size	L Inch	L mm	Z Inch	Z mm	L1 Inch	L1 mm	D1	D2
MPA5243 0030201	3/8" x 1/4"	1.73	44.0	1.02	26.0	0.83	21.0	3/8"	1/4"
MPA5243 0040301	1/2" x 3/8"	1.77	45.0	1.06	27.0	0.81	20.5	1/2"	3/8"
MPA5243 0050301	5/8" x 3/8"	1.87	47.5	1.16	29.5	0.94	24.0	5/8"	3/8"
MPA5243 0050401	5/8" x 1/2"	1.81	46.0	1.12	28.5	0.94	24.0	5/8"	1/2"
MPA5243 0060401	3/4" x 1/2"	2.09	53.0	1.40	35.5	0.98	25.0	3/4"	1/2"
MPA5243 0060501	3/4" x 5/8"	2.11	53.5	1.28	32.5	0.98	25.0	3/4"	5/8"
MPA5243 0070401	7/8" x 1/2"	2.13	54.0	1.44	36.5	1.06	27.0	7/8"	1/2"
MPA5243 0070501	7/8" x 5/8"	2.15	54.5	1.32	33.5	1.06	27.0	7/8"	5/8"
MPA5243 0070601	7/8" x 3/4"	2.09	53.0	1.22	31.0	1.06	27.0	7/8"	3/4"
MPA5243 0090401	1 1/8" x 1/2"	2.40	61.0	1.71	43.5	1.12	28.5	1 1/8"	1/2"
MPA5243 0090501	1 1/8" x 5/8"	2.50	63.5	1.67	42.5	1.12	28.5	1 1/8"	5/8"
MPA5243 0090601	1 1/8" x 3/4"	2.36	60.0	1.50	38.0	1.12	28.5	1 1/8"	3/4"
MPA5243 0090701	1 1/8" x 7/8"	2.34	59.5	1.40	35.5	1.12	28.5	1 1/8"	7/8"

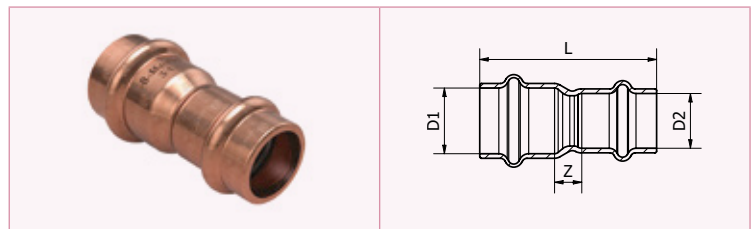

Reducing Coupler

Code	Size	L Inch	L mm	Z Inch	Z mm	D1	D2
MPA5240 0030201	3/8" x 1/4"	1.65	42.0	0.24	6.0	3/8"	1/4"
MPA5240 0040201	1/2" x 1/4"	1.73	44.0	0.33	8.5	1/2"	1/4"
MPA5240 0040301	1/2" x 3/8"	1.67	42.5	0.28	7.0	1/2"	3/8"
MPA5240 0050201	5/8" x 1/4"	2.05	52.0	0.51	13.0	5/8"	1/4"
MPA5240 0050301	5/8" x 3/8"	1.87	47.5	0.33	8.5	5/8"	3/8"
MPA5240 0050401	5/8" x 1/2"	1.79	45.5	0.28	7.0	5/8"	1/2"
MPA5240 0060301	3/4" x 3/8"	2.01	51.0	0.43	11.0	3/4"	3/8"
MPA5240 0060401	3/4" x 1/2"	1.81	46.0	0.26	6.5	3/4"	1/2"
MPA5240 0060501	3/4" x 5/8"	2.07	52.5	0.37	9.5	3/4"	5/8"
MPA5240 0070401	7/8" x 1/2"	2.07	52.5	0.43	11.0	7/8"	1/2"
MPA5240 0070501	7/8" x 5/8"	2.07	52.5	0.30	7.5	7/8"	5/8"
MPA5240 0070601	7/8" x 3/4"	2.07	52.5	0.26	6.5	7/8"	3/4"
MPA5240 0080601	1" x 3/4"	2.17	55.0	0.37	9.5	1"	3/4"
MPA5240 0090501	1 1/8" x 5/8"	2.17	55.0	0.33	8.5	1 1/8"	5/8"
MPA5240 0090601	1 1/8" x 3/4"	2.26	57.5	0.39	10.0	1 1/8"	3/4"
MPA5240 0090701	1 1/8" x 7/8"	2.28	58.0	0.33	8.5	1 1/8"	7/8"
MPA5240 0090801	1 1/8" x 1"	2.20	56.0	0.28	7.0	1 1/8"	1"

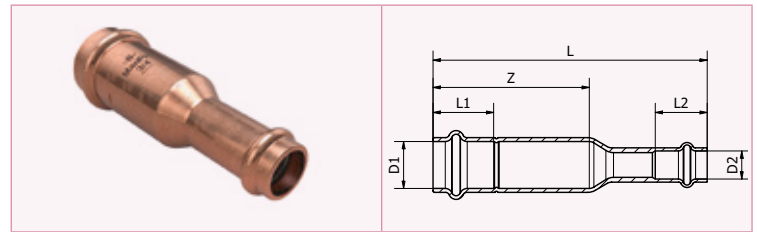

Long Reducing Coupler

Code	Size	D1 inch	D2 inch	L inch	L mm	L1 inch	L1 mm	L2 inch	L2 mm	Z inch	Z mm
MPA5240L0030201	3/8" x 1/4"	3/8"	1/4"	3.72	94.5	0.71	18.0	0.71	18.0	2.28	58.0
MPA5240L0050301	5/8" x 3/8"	5/8"	3/8"	3.74	95.0	0.83	21.0	0.71	18.0	2.19	55.5
MPA5240L0050401	5/8" x 1/2"	5/8"	1/2"	3.74	95.0	0.83	21.0	0.69	17.5	2.19	55.5
MPA5240L0080501	1" x 5/8"	1"	5/8"	3.94	100.0	0.93	23.5	0.83	21.0	2.09	53.0

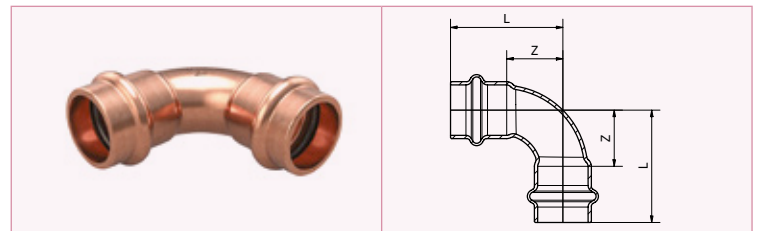

90° Bend

Code	Size	L Inch	L mm	Z Inch	Z mm
MPA5002 0020001	1/4"	1.28	32.5	0.57	14.5
MPA5002 0030001	3/8"	1.30	33.0	0.59	15.0
MPA5002 0040001	1/2"	1.24	31.5	0.55	14.0
MPA5002 0050001	5/8"	1.54	39.0	0.71	18.0
MPA5002 0060001	3/4"	1.67	42.5	0.81	20.5
MPA5002 0070001	7/8"	1.97	50.0	1.02	26.0
MPA5002 0080001	1"	2.09	53.0	1.16	29.5
MPA5002 0090001	1 1/8"	2.24	57.0	1.24	31.5

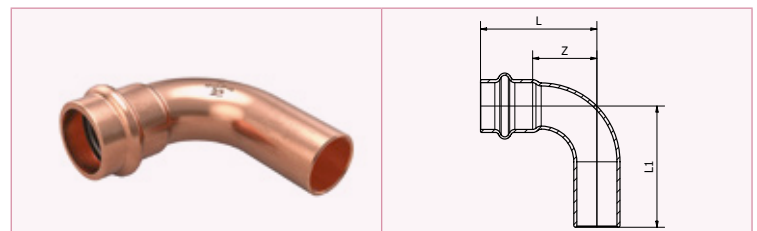

90° Street Bend

Code	Size	L Inch	L mm	L1 Inch	L1 mm	Z Inch	Z mm
MPA5001 0030001	3/8"	1.30	33.0	1.36	34.5	0.59	15.0
MPA5001 0040001	1/2"	1.24	31.5	1.36	34.5	0.55	14.0
MPA5001 0050001	5/8"	1.54	39.0	1.77	45.0	0.71	18.0
MPA5001 0060001	3/4"	1.67	42.5	1.89	48.0	0.81	20.5
MPA5001 0070001	7/8"	1.97	50.0	2.09	53.0	1.02	26.0
MPA5001 0080001	1"	2.13	54.0	2.20	56.0	1.22	33
MPA5001 0090001	1 1/8"	2.24	57.0	2.42	61.5	1.24	31.5

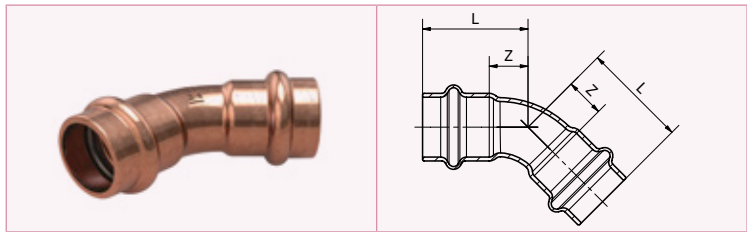

45° Obtuse Elbow

Code	Size	L Inch	L mm	Z Inch	Z mm
MPA5041 0020001	1/4"	0.93	23.5	0.22	5.5
MPA5041 0030001	3/8"	1.02	26.0	0.31	8.0
MPA5041 0040001	1/2"	0.94	24.0	0.26	6.5
MPA5041 0050001	5/8"	1.10	28.0	0.28	7.0
MPA5041 0060001	3/4"	1.24	31.5	0.37	9.5
MPA5041 0070001	7/8"	1.34	34.0	0.39	10.0
MPA5041 0080001	1"	1.40	35.5	0.47	12.0
MPA5041 0090001	1 1/8"	1.56	39.5	0.55	14.0

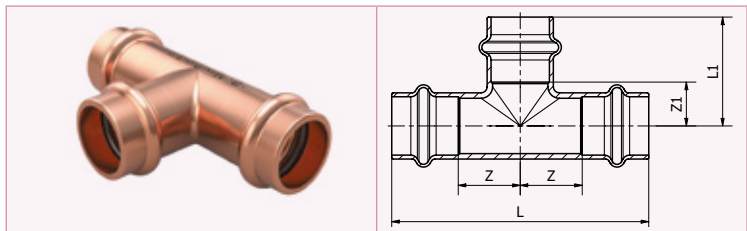

Equal Tee

Code	Size	L Inch	L mm	L1 Inch	L1 mm	Z Inch	Z mm	Z1 Inch	Z1 mm
MPA5T 002020201	1/4"	2.13	54.0	1.06	27.0	0.35	9.0	0.35	9.0
MPA5T 003030301	3/8"	2.48	63.0	1.22	31.0	0.53	13.5	0.51	13.0
MPA5T 004040401	1/2"	2.60	66.0	1.10	28.0	0.61	15.5	0.41	10.5
MPA5T 005050501	5/8"	2.99	76.0	1.26	32.0	0.67	17.0	0.43	11.0
MPA5T 006060601	3/4"	3.31	84.0	1.42	36.0	0.79	20.0	0.55	14.0
MPA5T 007070701	7/8"	3.50	89.0	1.52	38.5	0.81	20.5	0.57	14.5
MPA5T 008080801	1"	3.62	92.0	1.57	40.0	0.89	22.5	0.65	16.5
MPA5T 009090901	1 1/8"	3.74	95.0	1.69	43.0	0.87	22.0	0.69	17.5

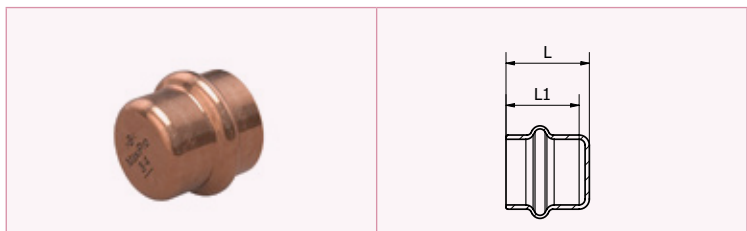

Stop End

Code	Size	L Inch	L mm	L1 Inch	L1 mm
MPA5301 0020001	1/4"	0.77	19.5	0.71	18.0
MPA5301 0030001	3/8"	0.77	19.5	0.71	18.0
MPA5301 0040001	1/2"	0.75	19.0	0.69	17.5
MPA5301 0050001	5/8"	0.89	22.5	0.83	21.0
MPA5301 0060001	3/4"	0.93	23.5	0.87	22.0
MPA5301 0070001	7/8"	1.02	26.0	0.94	24.0
MPA5301 0080001	1"	1.00	25.5	0.93	23.5
MPA5301 0090001	1 1/8"	1.08	27.5	1.00	25.5

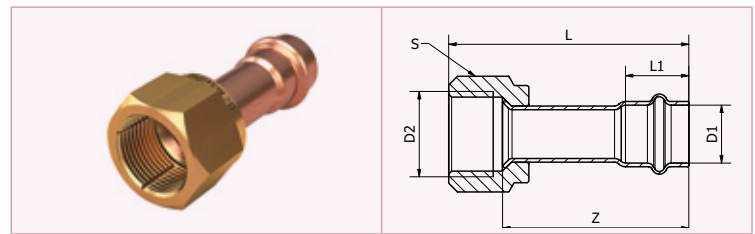

SAE Copper Formed Flare - Brass Nut

Code	Size	D1 inch	D2 inch	L inch	L mm	L1 inch	L1 mm	Z inch	Z mm	S inch	S mm
MPA5285G0020201	1/4"	1/4"	1/4"	2.13	54.0	0.71	18.0	1.81	46.0	0.67	17.0
MPA5285G0030301	3/8"	3/8"	3/8"	2.40	61.0	0.71	18.0	1.97	50.0	0.86	22.0
MPA5285G0040401	1/2"	1/2"	1/2"	2.50	63.5	0.69	17.5	2.03	51.5	0.95	24.0
MPA5285G0050501	5/8"	5/8"	5/8"	2.91	74.0	0.83	21.0	2.28	58.0	1.06	27.0
MPA5285G0060601	3/4"	3/4"	3/4"	3.21	81.5	0.86	22.0	2.50	63.5	1.34	34.0

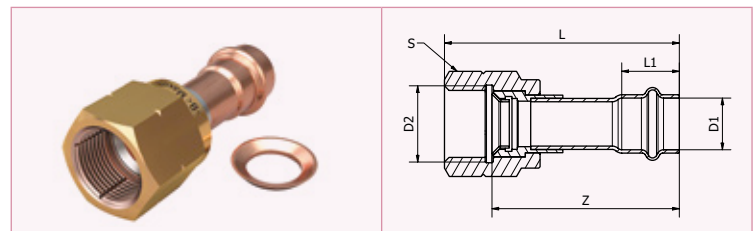

SAE Stainless Machined Flare - Brass Nut - Copper Washer

Code	Size	D1	D2	L inch	L mm	L1 inch	L1 mm	Z inch	Z mm	S inch	S mm
MPA5286G0020201	1/4"	1/4"	1/4"	2.52	64.0	0.71	18.0	2.19	55.5	0.67	17.0
MPA5286G0030301	3/8"	3/8"	3/8"	2.17	55.0	0.71	18.0	1.75	44.5	0.86	22.0
MPA5286G0040401	1/2"	1/2"	1/2"	2.54	64.5	0.69	17.5	2.07	52.5	0.95	24.0
MPA5286G0050501	5/8"	5/8"	5/8"	3.11	79.0	0.83	21.0	2.48	63.0	1.06	27.0
MPA5286G0060601	3/4"	3/4"	3/4"	3.35	85.0	0.86	22.0	2.64	67.0	1.34	34.0

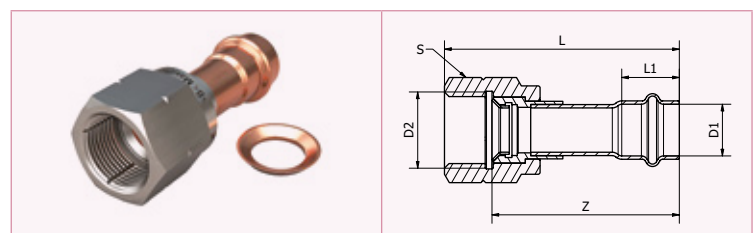

SAE Stainless Machined Flare - Stainless Nut - Copper Washer

Code	Size	D1	D2	L inch	L mm	L1 inch	L1 mm	Z inch	Z mm	S inch	S mm
MPA5289G0020201	1/4"	1/4"	1/4"	2.52	64.0	0.71	18.0	2.19	55.5	0.67	17.0
MPA5289G0030301	3/8"	3/8"	3/8"	2.17	55.0	0.71	18.0	1.75	44.5	0.86	22.0
MPA5289G0040401	1/2"	1/2"	1/2"	2.54	64.5	0.69	17.5	2.07	52.5	0.95	24.0
MPA5289G0050501	5/8"	5/8"	5/8"	3.11	79.0	0.83	21.0	2.48	63.0	1.06	27.0
MPA5289G0060601	3/4"	3/4"	3/4"	3.35	85.0	0.86	22.0	2.64	67.0	1.34	34.0

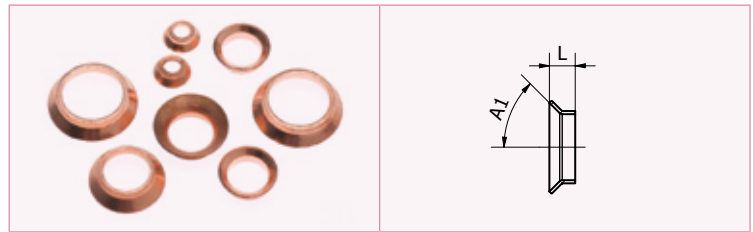

Flare Copper Washer

Code	Size	L inch	L mm	A1
MPA5287 0020001	1/4"	0.12	3.0	45°
MPA5287 0030001	3/8"	0.14	3.5	45°
MPA5287 0040001	1/2"	0.18	4.5	45°
MPA5287 0050001	5/8"	0.18	4.5	45°
MPA5287 0060001	3/4"	0.26	6.5	45°

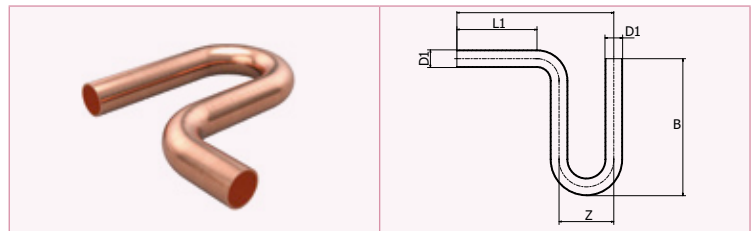

P-Trap

Code	Size	D1 inch	L inch	L mm	L1 inch	L1 mm	B inch	B mm	Z inch	Z mm
MPA5698 0050001	5/8"	5/8"	6.73	171.0	4.07	103.5	5.96	151.5	1.77	45.0
MPA5698 0060001	3/4"	3/4"	6.77	172.0	3.58	91.0	6.24	158.5	2.12	54.0
MPA5698 0070001	7/8"	7/8"	6.73	171.0	2.83	72.0	6.69	170.0	2.60	66.0
MPA5698 0090001	1 1/8"	1 1/8"	6.69	170.0	1.73	44.0	6.83	173.5	3.31	84.0

Note: Not UL approved.



Depth Gauge and Marker

Code	Description
MPA Depth Gauge	>B< MaxiPro Depth Gauge and Marker

Press Fitting Lubricant



Code	Size
MPABPSOIL100ML	100 ml

18.0 Five-Year Limited Warranty

Conex Universal Ltd. warrants that its >B< MaxiPro fittings will be free of material defects resulting from errors in manufacture, for five years from the date of first purchase by an end user. This warranty will be void if not professionally installed by a trained and certified >B< MaxiPro installer*, and used and maintained in accordance with the installation and maintenance instructions detailed in the >B< MaxiPro technical brochure.

THERE ARE NO WARRANTIES WHICH EXTEND BEYOND THIS DESCRIPTION, EXCEPT FOR ANY REQUIREMENTS THAT ARE LEGALLY MANDATED IN THE JURISDICTION OF THE FIRST END USER'S PREMISES. THIS WARRANTY IS LIMITED TO THE REPAIR OR REPLACEMENT OF MATERIALLY DEFECTIVE FITTINGS AT THE SOLE DISCRETION OF CONEX UNIVERSAL LTD.

At the request of Conex Universal Ltd. the claimed defective fitting(s) must be returned to the address below.** Conex Universal Ltd. reserves the right to inspect and test claimed defective fittings before deciding whether to repair or replace a fitting claimed to be defective.

This warranty is subject to the following additional conditions:

- A. Any claimed defect(s) must be reported to Conex Universal Ltd. within one month of the first occurrence of any such claimed defect, clearly setting out the nature of the claim and the circumstances surrounding it.
- B. Conex Universal Ltd. shall have no liability in respect of any fitting claimed to be defective if any of the following circumstances apply:
- defective installation;
 - normal wear and tear;
 - wilful misconduct;
 - negligence or omissions of any party other than Conex Universal Ltd.;
 - abnormal working or environmental conditions;

- failure to follow the installation and maintenance instructions detailed in the >B< MaxiPro technical brochure, and any other instructions of Conex Universal Ltd. communicated through the Conex Bänninger website or its successor, www.conexbanninger.com (the Website) or otherwise;
- misuse (which includes any use of the fittings for a purpose or in a situation / environment or for an application other than that for which it was designed according to the specifications of the fittings as described on the Website or in other materials provided to the buyer from Conex Universal Ltd.); or
- alteration or repair of any fitting without the prior written approval of Conex Universal Ltd..

C. At the request of Conex Universal Ltd., the person claiming under this warranty must deliver to Conex Universal Ltd. written evidence of the date of first purchase by an end user of the products claimed to be defective.

*All certified >B< MaxiPro installers must have participated in and passed the requisite Conex Universal Ltd., >B< MaxiPro product course, or have otherwise been approved by Conex Universal Ltd. to use and install the >B< MaxiPro product. In either case, all certified >B< MaxiPro installers must have valid training certificates, which can be made available for proof of certification upon request.

** The address for returns is:

Customer Service

IBP Group LLC.

24 Cathedral Place, Suite 400, St Augustine, Florida 32084.

19.0 UL 207 Certificates of Compliance

CERTIFICATE OF COMPLIANCE

Certificate Number 20180301-SA44668
Report Reference SA44668-20160808
Issue Date 2018-MARCH-01

Issued to: Conex Universal Limited
 Global House
 95 Vantage Point, The Pensnett Estate
 Kingswinford
 DY6 7FT UNITED KINGDOM

This is to certify that representative samples of REFRIGERATION, FITTINGS
 USL, CNL – Refrigeration Fittings, >B< MaxiPro, MPA Series.

Have been investigated by UL in accordance with the Standard(s) indicated on this Certificate.

Standard(s) for Safety: UL 207 - Standard for Refrigerant-Containing Components and Accessories, Nonelectrical
 CSA C22.2 No. 140.3-15 - Standard for Refrigerant-containing Components for use in Electrical Equipment
 UL 109 - Standard for Tube Fittings for Flammable and Combustible Fluids, Refrigeration Service, and Marine Use - Edition 6

Additional Information: See the UL Online Certifications Directory at www.ul.com/database for additional information

Only those products bearing the UL Certification Mark should be considered as being covered by UL's Certification and Follow-Up Service.

Look for the UL Certification Mark on the product.

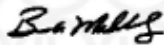

Bruce Mahrenholz, Director North American Certification Program
 UL LLC

Any information and documentation involving UL Mark services are provided on behalf of UL LLC (UL) or any authorized licensee of UL. For questions, please contact a local UL Customer Service Representative at <http://ul.com/about/locations/>



CERTIFICATE OF COMPLIANCE

Certificate Number 20180409-SA44668
Report Reference SA44668-20180406
Issue Date 2018-APRIL-09

Issued to: Conex Universal Limited
 Global House
 95 Vantage Point, The Pensnett Estate
 Kingswinford
 DY6 7FT, UNITED KINGDOM

This is to certify that representative samples of COMPONENT - REFRIGERATION, FITTINGS
 >B< MaxiPro, MPA Series

Have been investigated by UL in accordance with the Standard(s) indicated on this Certificate.

Standard(s) for Safety: UL 207, Refrigerant-Containing Components and Accessories, Nonelectrical.
 UL 109, Tube Fittings for Flammable and Combustible Fluids, Refrigeration Service, and Marine Use.
 CSA C22.2 No. 140.3-15, Refrigerant-containing Components for use in Electrical Equipment.

Additional Information: See the UL Online Certifications Directory at www.ul.com/database for additional information

Only those products bearing the UL Certification Mark should be considered as being covered by UL's Certification and Follow-Up Service.

The UL Recognized Component Mark generally consists of the manufacturer's identification and catalog number, model number or other product designation as specified under "Marking" for the particular Recognition as published in the appropriate UL Directory. As a supplementary means of identifying products that have been produced under UL's Component Recognition Program, UL's Recognized Component Mark: , may be used in conjunction with the required Recognized Marks. The Recognized Component Mark is required when specified in the UL Directory preceding the recognitions or under "Markings" for the individual recognitions.

Recognized components are incomplete in certain constructional features or restricted in performance capabilities and are intended for use as components of complete equipment submitted for investigation rather than for direct separate installation in the field. The final acceptance of the component is dependent upon its installation and use in complete equipment submitted to UL LLC.

Look for the UL Certification Mark on the product.

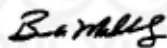

Bruce Mahrenholz, Director North American Certification Program
 UL LLC



Any information and documentation involving UL Mark services are provided on behalf of UL LLC (UL) or any authorized licensee of UL. For questions, please contact a local UL Customer Service Representative at http://ul.com/aboutul/locations/

20.0 ICC-ES, PMG-1440 Product Report - Certificate

ES ICC EVALUATION SERVICE
In Cooperation with **Innovation** RESEARCH LABS

Most Widely Accepted and Trusted

ICC-ES Report

PMG-1440

ICC-ES | (800) 423-6587 | (562) 699-0543 | www.icc-es.org

Reissued 03/07/2019
This report is subject to renewal 09/2019

EVALUATION SUBJECT:

>B< MAXIPRO PRESS FITTINGS FOR AC AND REFRIGERATION APPLICATION

DIVISION:

23 00 00—HEATING, VENTILATING AND AIR CONDITIONING

SECTION:

23 20 00—HVAC PIPE AND FITTINGS

Report Holder:

CONEX UNIVERSAL LTD.

Look for the ICC-ES marks of Conformity!



ICC-ES Evaluation Reports are not to be construed as representing aesthetics or any other attributes not specifically addressed, nor are they to be construed as an endorsement of the subject of the report or a recommendation for its use. There is no warranty by ICC Evaluation Service, LLC, express or implied, as to any finding or other matter in this report, or as to any product covered by the report. Copyright © 2019 ICC Evaluation Service, LLC. All rights reserved.





ICC-ES PMG Product Certificate

PMG-1440



Effective Date: September 2018

Revision Date: March 07, 2019

This listing is subject to re-examination in one year.

www.icc-es-pmg.org | (800) 423-6587 | (562) 699-0543 A Subsidiary of the International Code Council®

CSI: DIVISION: 23 00 00—HEATING, VENTILATING AND AIR CONDITIONING (HVAC)
 Section: 23 20 00—HVAC Pipe and Fittings

Product certification system:

The ICC-ES product certification system includes testing samples taken from the market or supplier's stock, or a combination of both, to verify compliance with applicable codes and standards. The system also involves factory inspections, and assessment and surveillance of the supplier's quality system.

Products: >B< MaxiPro Press Fittings for AC and Refrigeration Applications

Listee: Conex Universal Ltd.
 Global House, 95 Vantage Point, The Pensnett Trading Estate
 Kingswinford, West Midlands, DY67FT, UK
www.conexbanninger.com

Compliance with the following codes:

- 2018, 2015, 2012, 2009 and 2006 *International Mechanical Code*® (IMC)
- 2018, 2015, 2012, 2009 and 2006 *International Residential Code*® (IRC)
- 2018, 2015, 2012, 2009 and 2006 *Uniform Mechanical Code*® (UMC)*

**Copyrighted publication of the International Association of Plumbing and Mechanical Officials.*

Compliance with the following standards:

- UL 207 (Edition 8), Standard for Refrigerant-Containing Components and Accessories, Nonelectrical
- UL 1963 (Edition 4), Standard for Refrigerant Recovery/Recycling Equipment
- UL 109 (Edition 6), Standard for Tube Fittings for Flammable and Combustible Fluids, Refrigeration Service, and Marine Use

Identification:

The press fittings shall be legibly and permanently marked with the manufacturer's name, tubing size, temperature and pressure rating, and the ICC-ES PMG listing mark.

Installation:

The press fittings must be installed in accordance with the manufacturer's published installation instructions, the applicable codes and this listing.

Mechanical joints shall not be used on annealed temper copper tube in sizes larger than 7/8-inch (22.2 mm) OD size per IMC and 3/4" of an inch nominal size per UMC.

Listings are not to be construed as representing aesthetics or any other attributes not specifically addressed, nor are they to be construed as an endorsement of the subject of the listing or a recommendation for its use. There is no warranty by ICC Evaluation Service, LLC, express or implied, as to any finding or other matter in this listing, or as to any product covered by the listing.



Models:

The press fittings are intended for connection of copper tubing approved by the manufacturer. The connection is accomplished by pressing (solder-free) the fitting to a pipe using the manufacturer's recommended tool. The press fittings are only suitable for use with the following refrigerants: R32, R-125, R134a, R290(A3), R404A, R407A, R407C, R407F, R407H, R410A, R417A, R421A, R422B, R422D, R427A, R438A, R448A, R449A, R450A, R452A, R452C, R507A, R513A, R513B, R600A(A3), R718, R1234ze, R1234yf, R444A, R447A, R447B, R452B, R454A, R454B, R454C, R457A, R459A. Compatible Oils: POE, AB, PAO, PVE and MO oil.

Model Name: >B<MaxiPro

Size	Code Number	Fitting Type
1/4"	MPA5270 0020000	Straight Coupler
3/8"	MPA5270 0030000	Straight Coupler
1/2"	MPA5270 0040000	Straight Coupler
5/8"	MPA5270 0050000	Straight Coupler
3/4"	MPA5270 0060000	Straight Coupler
7/8"	MPA5270 0070000	Straight Coupler
1"	MPA5270 0080000	Straight Coupler
1-1/8"	MPA5270 0090000	Straight Coupler
1/4"	MPA5002 0020000	90 Degree Bend
3/8"	MPA5002 0030000	90 Degree Bend
1/2"	MPA5002 0040000	90 Degree Bend
5/8"	MPA5002 0050000	90 Degree Bend
3/4"	MPA5002 0060000	90 Degree Bend
7/8"	MPA5002 0070000	90 Degree Bend
1"	MPA5002 0080000	90 Degree Bend
1-1/8"	MPA5002 0090000	90 Degree Bend
1/4"	MPA5001 0030000	90 Degree Street Bend
3/8"	MPA5001 0040000	90 Degree Street Bend
1/2"	MPA5001 0050000	90 Degree Street Bend
5/8"	MPA5001 0060000	90 Degree Street Bend
3/4"	MPA5001 0070000	90 Degree Street Bend
7/8"	MPA5001 0080000	90 Degree Street Bend
1"	MPA5001 0090000	90 Degree Street Bend
1/4"	MPA5130 0020202	Equal Tee
3/8"	MPA5130 0030303	Equal Tee
1/2"	MPA5130 0040404	Equal Tee
5/8"	MPA5130 0050505	Equal Tee
3/4"	MPA5130 0060606	Equal Tee
7/8"	MPA5130 0070707	Equal Tee
1"	MPA5130 0080808	Equal Tee
1-1/8"	MPA5130 0090909	Equal Tee
3/8" x 1/4"	MPA5240 0030200	Reducer Coupler
1/2" x 1/4"	MPA5240 0040200	Reducer Coupler
1/2" x 3/8"	MPA5240 0040300	Reducer Coupler
5/8" x 1/4"	MPA5240 0050200	Reducer Coupler
5/8" x 3/8"	MPA5240 0050300	Reducer Coupler
5/8" x 1/2"	MPA5240 0050400	Reducer Coupler
3/4" x 3/8"	MPA5240 0060300	Reducer Coupler
3/4" x 1/2"	MPA5240 0060400	Reducer Coupler
3/4" x 5/8"	MPA5240 0060500	Reducer Coupler
7/8" x 1/2"	MPA5240 0070400	Reducer Coupler
7/8" x 5/8"	MPA5240 0070500	Reducer Coupler
7/8" x 3/4"	MPA5240 0070600	Reducer Coupler

1" x 3/4"	MPA5240 0080600	Reducer Coupler
1-1/8" x 5/8"	MPA5240 0090500	Reducer Coupler
1-1/8" x 3/4"	MPA5240 0090600	Reducer Coupler
1-1/8" x 7/8"	MPA5240 0090700	Reducer Coupler
1-1/8" x 1"	MPA5240 0090800	Reducer Coupler
3/8" x 1/4"	MPA5243 0030200	Fitting Reducer
1/2" x 3/8"	MPA5243 0040300	Fitting Reducer
5/8" x 3/8"	MPA5243 0050300	Fitting Reducer
5/8" x 1/2"	MPA5243 0050400	Fitting Reducer
3/4" x 1/2"	MPA5243 0060400	Fitting Reducer
3/4" x 5/8"	MPA5243 0060500	Fitting Reducer
7/8" x 1/2"	MPA5243 0070400	Fitting Reducer
7/8" x 5/8"	MPA5243 0070500	Fitting Reducer
7/8" x 3/4"	MPA5243 0070600	Fitting Reducer
1-1/8" x 1/2"	MPA5243 0090400	Fitting Reducer
1-1/8" x 5/8"	MPA5243 0090500	Fitting Reducer
1-1/8" x 3/4"	MPA5243 0090600	Fitting Reducer
1-1/8" x 7/8"	MPA5243 0090700	Fitting Reducer
1/4"	MPA5041 0020000	45 Degree Bend
3/8"	MPA5041 0030000	45 Degree Bend
1/2"	MPA5041 0040000	45 Degree Bend
5/8"	MPA5041 0050000	45 Degree Bend
3/4"	MPA5041 0060000	45 Degree Bend
7/8"	MPA5041 0070000	45 Degree Bend
1"	MPA5041 0080000	45 Degree Bend
1-1/8"	MPA5041 0090000	45 Degree Bend
1/4"	MPA5301 0020000	Stop End
3/8"	MPA5301 0030000	Stop End
1/2"	MPA5301 0040000	Stop End
5/8"	MPA5301 0050000	Stop End
3/4"	MPA5301 0060000	Stop End
7/8"	MPA5301 0070000	Stop End
1"	MPA5301 0080000	Stop End
1-1/8"	MPA5301 0090000	Stop End
3/8" x 1/4"	MPA5240L0030200	Long Reducer Coupler
5/8" x 3/8"	MPA5240L0050300	Long Reducer Coupler
1" x 5/8"	MPA5240L0080500	Long Reducer Coupler
1/4"	MPA5270L0020000	Long Straight Coupler
3/8"	MPA5270L0030000	Long Straight Coupler
1/2"	MPA5270L0040000	Long Straight Coupler
5/8"	MPA5270L0050000	Long Straight Coupler
3/4"	MPA5270L0060000	Long Straight Coupler
7/8"	MPA5270L0070000	Long Straight Coupler
1"	MPA5270L0080000	Long Straight Coupler
1-1/8"	MPA5270L0090000	Long Straight Coupler
1/4"	MPA5275L0020000	Repair Coupler
3/8"	MPA5275L0030000	Repair Coupler
1/2"	MPA5275L0040000	Repair Coupler
5/8"	MPA5275L0050000	Repair Coupler
3/4"	MPA5275L0060000	Repair Coupler
7/8"	MPA5275L0070000	Repair Coupler
1"	MPA5275L0080000	Repair Coupler
1-1/8"	MPA5275L0090000	Repair Coupler
1/4" x 1/4" SAE Flare	MPA5286G0020200	SAE Flare Adaptor

3/8" x 3/8" SAE Flare	MPA5286G0030300	SAE Flare Adaptor
1/2" x 1/2" SAE Flare	MPA5286G0040400	SAE Flare Adaptor
5/8" x 5/8" SAE Flare	MPA5286G0050500	SAE Flare Adaptor
3/4" x 3/4" SAE Flare	MPA5286G0050500	SAE Flare Adaptor
1/4" x 1/4" SAE Flare	MPA5285G0020200	SAE Flare Adaptor
3/8" x 3/8" SAE Flare	MPA5285G0030300	SAE Flare Adaptor
1/2" x 1/2" SAE Flare	MPA5285G0040400	SAE Flare Adaptor
5/8" x 5/8" SAE Flare	MPA5285G0050500	SAE Flare Adaptor
3/4" x 3/4" SAE Flare	MPA5285G0050500	SAE Flare Adaptor
1/4" x 1/4" SAE Flare	MPA5289G0020200	SAE Flare Adaptor
3/8" x 3/8" SAE Flare	MPA5289G0030300	SAE Flare Adaptor
1/2" x 1/2" SAE Flare	MPA5289G0040400	SAE Flare Adaptor
5/8" x 5/8" SAE Flare	MPA5289G0050500	SAE Flare Adaptor
3/4" x 3/4" SAE Flare	MPA5289G0050500	SAE Flare Adaptor

Ratings:

Sizes	Design Pressure, psig	Maximum Abnormal Pressure, psi	Continuous Operating Temperature
1/4"	700	700	250°F (121°C)
3/8"	700	700	250°F (121°C)
1/2"	700	700	250°F (121°C)
5/8"	700	700	250°F (121°C)
3/4"	700	700	250°F (121°C)
7/8"	700	700	250°F (121°C)
1-1/8"	700	700	250°F (121°C)

Conditions of Listing:

1. The press fittings are only suitable for use with the following refrigerants: R32, R-125, R134a, R290(A3), R404A, R407A, R407C, R407F, R407H, R410A, R417A, R421A, R422B, R422D, R427A, R438A, R448A, R449A, R450A, R452A, R452C, R507, R507A, R513A, R-513B, R600A(A3), R718, R1234ze, R1234yf, R444A, R447A, R447B, R452B, R454A, R454B, R454C, R457A, R459A.
2. Compatible Oils: POE, AB, PAO, PVE and MO oil.
3. Mechanical joints shall not be used on annealed temper copper tube in sizes larger than 7/8-inch (22.2 mm) OD size per IMC and 3/4" of an inch nominal size per UMC.
4. The installation must be pressure-tested for leaks in the presence of the code official or the code official's designated representative.
5. When installation is in fire-resistance-rated assemblies, evidence must be provided to the code official of compliance with *International Building Code*® (IBC) Section 713 (penetrations), *Uniform Building Code* (UBC) Section 709 (walls and partitions) or UBC Section 710 (floor/ceiling or roof/ceiling), as applicable.
6. The fittings must not be used as a source of electrical ground.
7. When the system is embedded in concrete, tubing must be covered a minimum of 3/4 inch (19.1 mm) and installation must comply with IBC Section 1906.3 or UBC Section 1906.3, as applicable.
8. The press fittings are manufactured by Conex Universal Ltd. and are under a quality control program with surveillance inspections annually by ICC-ES.

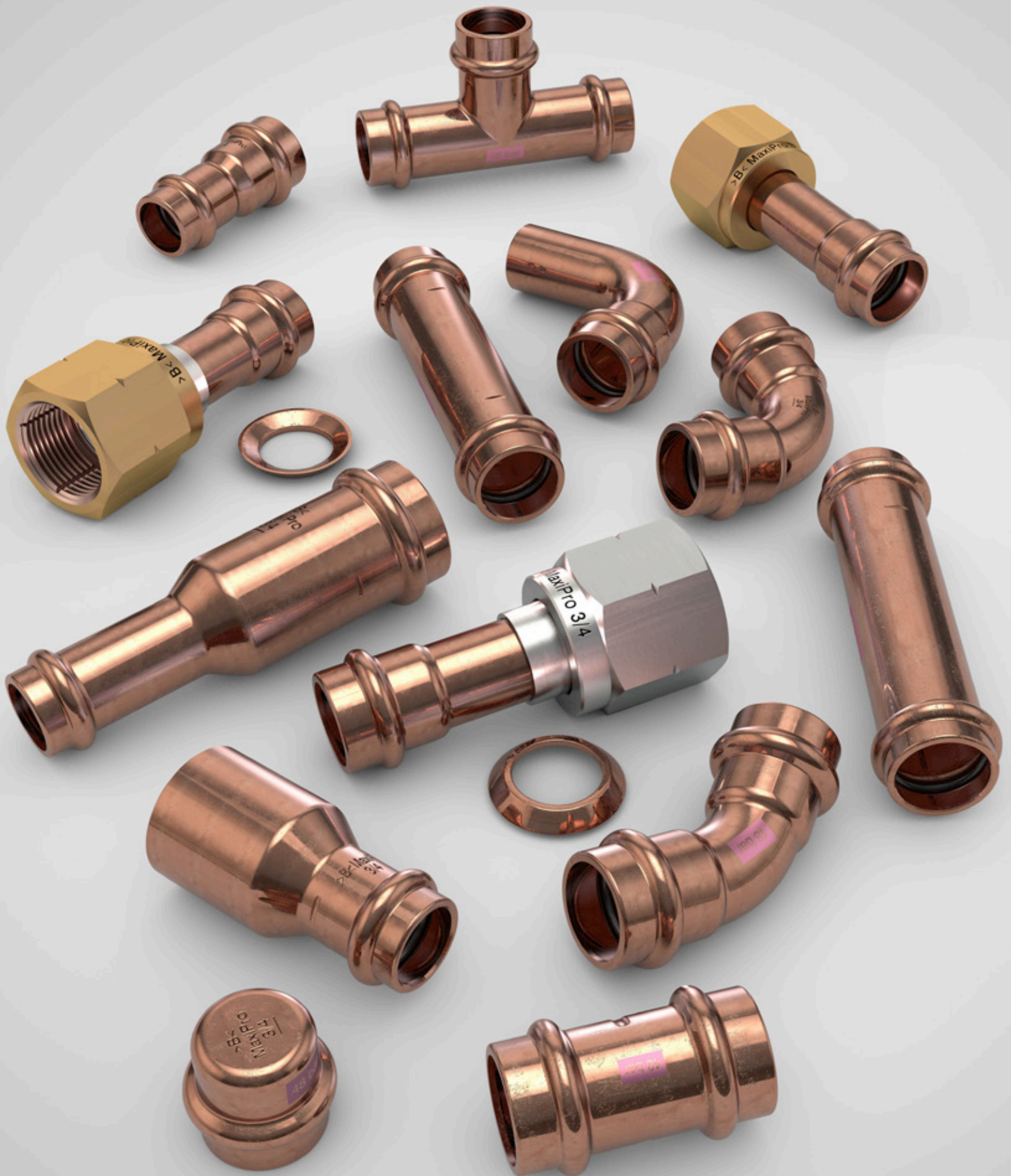

Conex | Bänninger

Conex | Bänninger
>B< Press

Conex | Bänninger
>B< Press Gas

Conex | Bänninger
>B< Press Solar

Conex | Bänninger
>B< Press XL

Conex | Bänninger
>B< Press Carbon

Conex | Bänninger
>B< Press Inox

Conex | Bänninger
>B< MaxiPro

Conex | Bänninger
>B< ACR

K65

Conex | Bänninger
>B< Push

Conex | Bänninger
>B< Flex

Conex | Bänninger
>B< Oyster

Conex | Bänninger
>B< Sonic

Conex | Bänninger
Triflow Solder Ring

Conex | Bänninger
Delcop End Feed

Conex | Bänninger
Delbraze

Conex | Bänninger
Medical Gas

Conex | Bänninger
Valves

Conex | Bänninger
Conex Compression

Conex | Bänninger
Series 3000

Conex | Bänninger
Series 4000

Conex | Bänninger
Series 5000

Conex | Bänninger
Series 8000

Conex | Bänninger
OEM



IBP Group LLC. 24 Cathedral Place, Suite 400, St Augustine, FL 32084

Tel: 904-217-4970 | Fax: 904-460-2603 | Email: SalesUSA@IBPGroup.com | Website: www.conexbanninger.com

Global Headquarters:

Conex Universal Limited. Global House, 95 Vantage Point, The Pensnett Estate, Kingswinford, West Midlands, DY6 7FT, UNITED KINGDOM.

Tel: +44 (0) 121 557 2831 | Fax: +44 (0) 121 557 0185 | Email: salesuk@ibpgroup.com | Website: www.conexbanninger.com

The content of this publication is for general information only. It is the user's responsibility to determine suitability of any product for the purpose intended and reference should be made to our Technical Department if clarification is required. In the interests of technical development we reserve the right to change specification, design and materials without notice.

Conex Bänninger products are approved by numerous Standards Authorities and Certification Bodies. IBP trademarks are registered in numerous countries.

More information available online at: www.conexbanninger.com.